

**□□□□ V2.10.0~pre0~refs-pull-3173-  
merge~5171412b1a, 09 Oct 2023**

# Contents

<b>1</b>	<b>□□</b>	<b>1</b>
<b>2</b>	<b>HAL General Reference</b>	<b>2</b>
2.1	HAL Entity Names . . . . .	2
2.2	HAL General Naming Conventions . . . . .	2
2.3	Hardware Driver Naming Conventions . . . . .	3
2.3.1	Pins/Parameters names . . . . .	3
2.3.2	Function Names . . . . .	4
<b>3</b>	<b>Code Notes</b>	<b>5</b>
3.1	Intended audience . . . . .	5
3.2	Organization . . . . .	5
3.3	Terms and definitions . . . . .	5
3.4	Architecture overview . . . . .	6
3.4.1	LinuxCNC software architecture . . . . .	8
3.5	Motion Controller Introduction . . . . .	8
3.5.1	Motion Controller Modules . . . . .	8
3.6	Block diagrams and Data Flow . . . . .	10
3.7	Homing . . . . .	13
3.7.1	Homing state diagram . . . . .	13
3.7.2	Another homing diagram . . . . .	14
3.8	Commands . . . . .	14
3.8.1	ABORT . . . . .	14
3.8.1.1	Requirements . . . . .	15
3.8.1.2	Results . . . . .	15
3.8.2	FREE . . . . .	15
3.8.2.1	Requirements . . . . .	15
3.8.2.2	Results . . . . .	15
3.8.3	TELEOP . . . . .	15
3.8.3.1	Requirements . . . . .	16

3.8.3.2 Results	16
3.8.4 COORD	16
3.8.4.1 Requirements	16
3.8.4.2 Results	16
3.8.5 ENABLE	16
3.8.5.1 Requirements	16
3.8.5.2 Results	16
3.8.6 DISABLE	17
3.8.6.1 Requirements	17
3.8.6.2 Results	17
3.8.7 ENABLE_AMPLIFIER	17
3.8.7.1 Requirements	17
3.8.7.2 Results	17
3.8.8 DISABLE_AMPLIFIER	17
3.8.8.1 Requirements	17
3.8.8.2 Results	17
3.8.9 ACTIVATE_JOINT	17
3.8.9.1 Requirements	18
3.8.9.2 Results	18
3.8.10 DEACTIVATE_JOINT	18
3.8.10.1 Requirements	18
3.8.10.2 Results	18
3.8.11 ENABLE_WATCHDOG	18
3.8.11.1 Requirements	18
3.8.11.2 Results	18
3.8.12 DISABLE_WATCHDOG	18
3.8.12.1 Requirements	18
3.8.12.2 Results	18
3.8.13 PAUSE	19
3.8.13.1 Requirements	19
3.8.13.2 Results	19
3.8.14 RESUME	19
3.8.14.1 Requirements	19
3.8.14.2 Results	19
3.8.15 STEP	19
3.8.15.1 Requirements	19
3.8.15.2 Results	19
3.8.16 SCALE	19
3.8.16.1 Requirements	20

3.8.16.2Results	20
3.8.17OVERRIDE_LIMITS	20
3.8.17.1Requirements	20
3.8.17.2Results	20
3.8.18HOME	20
3.8.18.1Requirements	20
3.8.18.2Results	20
3.8.19JOG_CONT	20
3.8.19.1Requirements	21
3.8.19.2Results	21
3.8.20JOG_INCR	21
3.8.20.1Requirements	21
3.8.20.2Results	21
3.8.21JOG_ABS	21
3.8.21.1Requirements	21
3.8.21.2Results	22
3.8.22SET_LINE	22
3.8.23SET_CIRCLE	22
3.8.24SET_TELEOP_VECTOR	22
3.8.25PROBE	22
3.8.26CLEAR_PROBE_FLAG	22
3.8.27SET_xix	22
3.9 Backlash and Screw Error Compensation	23
3.10Task controller (EMCTASK)	23
3.10.1State	23
3.11IO controller (EMCIO)	23
3.12□□□□	23
3.13libnml Introduction	24
3.14LinkedList	24
3.15LinkedListNode	24
3.16SharedMemory	24
3.17ShmBuffer	24
3.18Timer	24
3.19Semaphore	25
3.20CMS	25
3.21Configuration file format	26
3.21.1Buffer line	26
3.21.2Type specific configs	27
3.21.3Process line	28

3.21.4	Configuration Comments	28
3.22	NML base class	29
3.22.1	NML internals	29
3.22.1.1	NML constructor	29
3.22.1.2	NML read/write	30
3.22.1.3	NMLmsg and NML relationships	30
3.23	Adding custom NML commands	30
3.24	The Tool Table and Toolchanger	30
3.24.1	Toolchanger abstraction in LinuxCNC	30
3.24.1.1	Nonrandom Toolchangers	31
3.24.1.2	Random Toolchangers	31
3.24.2	The Tool Table	31
3.24.3	G-codes affecting tools	32
3.24.3.1	Txxx	32
3.24.3.2	M6	32
3.24.3.3	G43/G43.1/G49	33
3.24.3.4	G10 L1/L10/L11	33
3.24.3.5	M61	34
3.24.3.6	G41/G41.1/G42/G42.1	34
3.24.3.7	G40	34
3.24.4	Internal state variables	35
3.24.4.1	IIO	35
3.24.4.2	interp	35
3.25	Reckoning of joints and axes	36
3.25.1	In the status buffer	36
3.25.2	In Motion	37
<b>4</b>	<b>NML Messages</b>	<b>38</b>
4.1	OPERATOR	38
4.2	JOINT	38
4.3	AXIS	38
4.4	JOG	39
4.5	TRAJ	39
4.6	MOTION	39
4.7	TASK	40
4.8	TOOL	40
4.9	AUX	40
4.10	SPINDLE	41
4.11	COOLANT	41
4.12	LUBE	41
4.13	IO (Input/Output)	41
4.14	Others	41

<b>5 Coding Style</b>	<b>42</b>
5.1 Do no harm	42
5.2 Tab Stops	42
5.3 Indentation	42
5.4 Placing Braces	42
5.5 Naming	43
5.6 Functions	43
5.7 Commenting	44
5.8 Shell Scripts & Makefiles	44
5.9 C++ Conventions	44
5.9.1 Specific method naming conventions	45
5.10 Python coding standards	45
5.11 Comp coding standards	45
<b>6 Building LinuxCNC</b>	<b>46</b>
6.1 <code>configure</code>	46
6.2 Downloading source tree	46
6.2.1 Quick Start	47
6.3 Supported Platforms	47
6.3.1 Realtime	48
6.4 Build modes	48
6.4.1 Building for Run In Place	48
6.4.1.1 <code>src/configure</code> arguments	48
6.4.1.2 <code>make</code> arguments	49
6.4.2 Building Debian Packages	49
6.4.2.1 LinuxCNC's <code>debian/configure</code> arguments	50
6.4.2.2 Satisfying Build Dependencies	51
6.4.2.3 Options for <code>dpkg-buildpackage</code>	52
6.4.2.4 Installing self-built Debian packages	53
6.5 Setting up the environment	53
6.5.1 Increase the locked memory limit	53
6.6 Building on Gentoo	54
6.7 Options for checking out the git repo	54
6.7.1 Fork us on GitHub	55
<b>7 Adding Configuration Selection Items</b>	<b>56</b>

<b>8</b>	<b>Contributing to LinuxCNC</b>	<b>57</b>
8.1	□□ . . . . .	57
8.2	Communication among LinuxCNC developers . . . . .	57
8.3	The LinuxCNC Source Forge project . . . . .	57
8.4	The Git Revision Control System . . . . .	57
	8.4.1 LinuxCNC official Git repo . . . . .	57
	8.4.2 Use of Git in the LinuxCNC project . . . . .	58
	8.4.3 git tutorials . . . . .	58
8.5	Overview of the process . . . . .	58
8.6	git configuration . . . . .	59
8.7	Effective use of git . . . . .	59
	8.7.1 Commit contents . . . . .	59
	8.7.2 Write good commit messages . . . . .	59
	8.7.3 Commit to the proper branch . . . . .	59
	8.7.4 Use multiple commits to organize changes . . . . .	60
	8.7.5 Follow the style of the surrounding code . . . . .	60
	8.7.6 Get rid of RTAPI_SUCCESS, use 0 instead . . . . .	60
	8.7.7 Simplify complicated history before sharing with fellow developers . . . . .	60
	8.7.8 Make sure every commit builds . . . . .	60
	8.7.9 Renaming files . . . . .	61
	8.7.10Prefer "rebase" . . . . .	61
8.8	Translations . . . . .	61
8.9	Other ways to contribute . . . . .	61
<b>9</b>	<b>Glossary</b>	<b>62</b>
<b>10</b>	<b>Legal Section</b>	<b>68</b>
	10.1 Copyright Terms . . . . .	68
	10.2 GNU Free Documentation License . . . . .	68

# Chapter 1



This handbook is a work in progress. If you are able to help with writing, editing, or graphic preparation please contact any member of the writing team or join and send an email to [emc-users@lists.sourceforge.net](mailto:emc-users@lists.sourceforge.net)

Copyright © 2000-2020 LinuxCNC.org

Permission is granted to copy, distribute and/or modify this document under the terms of the GNU Free Documentation License, Version 1.1 or any later version published by the Free Software Foundation; with no Invariant Sections, no Front-Cover Texts, and no Back-Cover Texts. A copy of the license is included in the section entitled "GNU Free Documentation License".

If you do not find the license you may order a copy from:

Free Software Foundation, Inc.  
51 Franklin Street  
Fifth Floor  
Boston, MA 02110-1301 USA.

(The English language version is authoritative)

LINUX® is the registered trademark of Linus Torvalds in the U.S. and other countries. The registered trademark Linux® is used pursuant to a sublicense from LMI, the exclusive licensee of Linus Torvalds, owner of the mark on a world-wide basis.

The LinuxCNC project is not affiliated with Debian®. *Debian* is a registered trademark owned by Software in the Public Interest, Inc.

The LinuxCNC project is not affiliated with UBUNTU®. *UBUNTU* is a registered trademark owned by Canonical Limited.



## Chapter 2

# HAL General Reference

### 2.1 HAL Entity Names

All HAL entities are accessible and manipulable by their names, so documenting the names of pins, signals, parameters, etc., is very important. Names in HAL have a maximum length of 41 characters (as defined by `HAL_NAME_LEN` in `hal.h`). Many names will be presented in the general form, with formatted text *<like-this>* representing fields of various values.

When pins, signals, or parameters are described for the first time, their name will be preceded by their type in parentheses (*float*) and followed by a brief description. Typical pins definitions look like these examples:

**(bit) `parport.<portnum>.pin-<pinnum>-in`**

The HAL pin associated with the physical input pin *<pinnum>* of the db25 connector.

**(float) `pid.<loopnum>.output`**

The PID loop output

Occasionally, an abbreviated version of the name may be used, for example the second pin above could be simply called with *.output* when it can be done without causing confusion.

### 2.2 HAL General Naming Conventions

Consistent naming conventions would make HAL much easier to use. For example, if every encoder driver provided the same set of pins and named them the same way, then it would be easy to change from one type of encoder driver to another. Unfortunately, like many open-source projects, HAL is a combination of things that were designed, and things that simply evolved. As a result, there are many inconsistencies. This section attempts to address that problem by defining some conventions, but it will probably be a while before all the modules are converted to follow them.

`Halcmd` and other low-level HAL utilities treat HAL names as single entities, with no internal structure. However, most modules do have some implicit structure. For example, a board provides several functional blocks, each block might have several channels, and each channel has one or more pins. This results in a structure that resembles a directory tree. Even though `halcmd` doesn't recognize the tree structure, proper choice of naming conventions will let it group related items together (since it sorts the names). In addition, higher level tools can be designed to recognize such structure, if the names provide the necessary information. To do that, all HAL components should follow these rules:

- Dots (".") separate levels of the hierarchy. This is analogous to the slash ("/") in a filename.

- Hyphens (“-”) separate words or fields in the same level of the hierarchy.
- HAL components should not use underscores or “MixedCase”.<sup>1</sup>
- Use only lowercase letters and numbers in names.

## 2.3 Hardware Driver Naming Conventions

---

□□

Most drivers do not follow these conventions in version 2.0. This chapter is really a guide for future developments.

---

### 2.3.1 Pins/Parameters names

Hardware drivers should use five fields (on three levels) to make up a pin or parameter name, as follows:

```
<device-name>.<device-num>.<io-type>.<chan-num>.<specific-name>
```

The individual fields are:

#### <device-name>

The device that the driver is intended to work with. This is most often an interface board of some type, but there are other possibilities.

#### <device-num>

It is possible to install more than one servo board, parallel port, or other hardware device in a computer. The device number identifies a specific device. Device numbers start at 0 and increment.

#### <io-type>

Most devices provide more than one type of I/O. Even the simple parallel port has both digital inputs and digital outputs. More complex boards can have digital inputs and outputs, encoder counters, pwm or step pulse generators, analog-to-digital converters, digital-to-analog converters, or other unique capabilities. The I/O type is used to identify the kind of I/O that a pin or parameter is associated with. Ideally, drivers that implement the same I/O type, even if for very different devices, should provide a consistent set of pins and parameters and identical behavior. For example, all digital inputs should behave the same when seen from inside the HAL, regardless of the device.

#### <chan-num>

Virtually every I/O device has multiple channels, and the channel number identifies one of them. Like device numbers, channel numbers start at zero and increment.<sup>2</sup> If more than one device is installed, the channel numbers on additional devices start over at zero. If it is possible to have a channel number greater than 9, then channel numbers should be two digits, with a leading zero on numbers less than 10 to preserve sort ordering. Some modules have pins and/or parameters that affect more than one channel. For example a PWM generator might have four channels with four independent “duty-cycle” inputs, but one “frequency” parameter that controls all four channels (due to hardware limitations). The frequency parameter should use “0-3” as the channel number.

---

<sup>1</sup>Underlined characters have been removed, but there are still a few cases of broken mixture, for example *pid.0.Pgain* in place of *pid.0.p-gain*.

<sup>2</sup>One exception to the “channel numbers start at zero” rule is the parallel port. Its HAL pins are numbered with the corresponding pin number on the DB-25 connector. This is convenient for wiring, but inconsistent with other drivers. There is some debate over whether this is a bug or a feature.

---

**<specific-name>**

An individual I/O channel might have just a single HAL pin associated with it, but most have more than one. For example, a digital input has two pins, one is the state of the physical pin, the other is the same thing inverted. That allows the configurator to choose between active high and active low inputs. For most io-types, there is a standard set of pins and parameters, (referred to as the "canonical interface") that the driver should implement. The canonical interfaces are described in the [Canonical Device Interfaces](#) chapter.

## Examples

**motenc.0.encoder.2.position**

The position output of the third encoder channel on the first Motenc board.

**stg.0.din.03.in**

The state of the fourth digital input on the first Servo-to-Go board.

**ppmc.0.pwm.00-03.frequency**

The carrier frequency used for PWM channels 0 through 3 on the first Pico Systems ppmc board.

## 2.3.2 Function Names

Hardware drivers usually only have two kinds of HAL functions, ones that read the hardware and update HAL pins, and ones that write to the hardware using data from HAL pins. They should be named as follows:

```
<device-name>-<device-num>.<io-type>-<chan-num-range>.read|write
```

**<device-name>**

The same as used for pins and parameters.

**<device-num>**

The specific device that the function will access.

**<io-type>**

Optional. A function may access all of the I/O on a board, or it may access only a certain type. For example, there may be independent functions for reading encoder counters and reading digital I/O. If such independent functions exist, the <io-type> field identifies the type of I/O they access. If a single function reads all I/O provided by the board, <io-type> is not used. <sup>3</sup>

**<chan-num-range>**

Optional. Used only if the <io-type> I/O is broken into groups and accessed by different functions.

**read|write**

Indicates whether the function reads the hardware or writes to it.

## Examples

**motenc.0.encoder.read**

Reads all encoders on the first motenc board.

**generic8255.0.din.09-15.read**

Reads the second 8 bit port on the first generic 8255 based digital I/O board.

**ppmc.0.write**

Writes all outputs (step generators, pwm, DACs, and digital) on the first Pico Systems ppmc board.

---

<sup>3</sup>Note to driver programmers: Do NOT implement separate functions for different I/O types unless they are interruptible and can work in independent threads. If interrupting an encoder read, reading digital inputs, and then resuming the encoder read will cause problems, then implement a single function that does everything.

# Chapter 3

## Code Notes

### 3.1 Intended audience

This document is a collection of notes about the internals of LinuxCNC. It is primarily of interest to developers, however much of the information here may also be of interest to system integrators and others who are simply curious about how LinuxCNC works. Much of this information is now outdated and has never been reviewed for accuracy.

### 3.2 Organization

There will be a chapter for each of the major components of LinuxCNC, as well as chapter(s) covering how they work together. This document is very much a work in progress, and its layout may change in the future.

### 3.3 Terms and definitions

- **AXIS** - An axis is one of the nine degrees of freedom that define a tool position in three-dimensional Cartesian space. Those nine axes are referred to as X, Y, Z, A, B, C, U, V, and W. The linear orthogonal coordinates X, Y, and Z determine where the tip of the tool is positioned. The angular coordinates A, B, and C determine the tool orientation. A second set of linear orthogonal coordinates U, V, and W allows tool motion (typically for cutting actions) relative to the previously offset and rotated axes. Unfortunately "axis" is also sometimes used to mean a degree of freedom of the machine itself, such as the saddle, table, or quill of a Bridgeport type milling machine. On a Bridgeport this causes no confusion, since movement of the table directly corresponds to movement along the X axis. However, the shoulder and elbow joints of a robot arm and the linear actuators of a hexapod do not correspond to movement along any Cartesian axis, and in general it is important to make the distinction between the Cartesian axes and the machine degrees of freedom. In this document, the latter will be called *joints*, not axes. The GUIs and some other parts of the code may not always follow this distinction, but the internals of the motion controller do.
  - **JOINT** - A joint is one of the movable parts of the machine. Joints are distinct from axes, although the two terms are sometimes (mis)used to mean the same thing. In LinuxCNC, a joint is a physical thing that can be moved, not a coordinate in space. For example, the quill, knee, saddle, and table of a Bridgeport mill are all joints. The shoulder, elbow, and wrist of a robot arm are joints, as are the linear actuators of a hexapod. Every joint has a motor or actuator of some type associated with it. Joints do not necessarily correspond to the X, Y, and Z axes, although for machines with trivial
-

kinematics that may be the case. Even on those machines, joint position and axis position are fundamentally different things. In this document, the terms *joint* and *axis* are used carefully to respect their distinct meanings. Unfortunately that isn't necessarily true everywhere else. In particular, GUIs for machines with trivial kinematics may gloss over or completely hide the distinction between joints and axes. In addition, the INI file uses the term *axis* for data that would more accurately be described as joint data, such as input and output scaling, etc.

---

□□

This distinction was made in version 2.8 of LinuxCNC. The INI file got a new section [JOINT\_<num>]. Many of the parameters that were previously proper to the [AXIS\_<letter>] section are now in the new section. Other sections, such as [KINS], also take on new parameters to match this. An update script has been provided to transform old INI files to the new axes/joints configuration.

---

- *POSE* - A pose is a fully specified position in 3D Cartesian space. In the LinuxCNC motion controller, when we refer to a pose we mean an EmcPose structure, containing six linear coordinates (X, Y, Z, U, V, and W) and three angular ones (A, B, and C).
- *coord*, or coordinated mode, means that all articulations are synchronized and they move together as directed by the higher-level code. It is the normal mode when machining. In coordinated mode, commands are assumed to be given in the Cartesian reference frame, and if the machine is not Cartesian, the commands are translated by the kinematics to drive each joint into the joint space as needed.
- *free* means that commands are interpreted in joint space. It is used to manually move (jog) individual joints, although it does not prevent them from moving multiple joints at once (I think). Homing is also done in free mode; in fact, machines with non-trivial kinematics must be homed before they can go into coord or teleop mode.
- *teleop* is the mode you probably need if you are jogging with a hexapod. The jog commands implemented by the motion controller are joint jogs, which work in free mode. But if you want to move a hexapod or similar machine along a cartesian axis in particular, you must operate more than one joint. That's what *teleop* is for.

## 3.4 Architecture overview

There are four components contained in the LinuxCNC Architecture: a motion controller (EMCMOT), a discrete IO controller (EMCIO), a task executor which coordinates them (EMCTASK) and several text-mode and graphical User Interfaces. Each of them will be described in the current document, both from the design point of view and from the developers point of view (where to find needed data, how to easily extend/modify things, etc.).

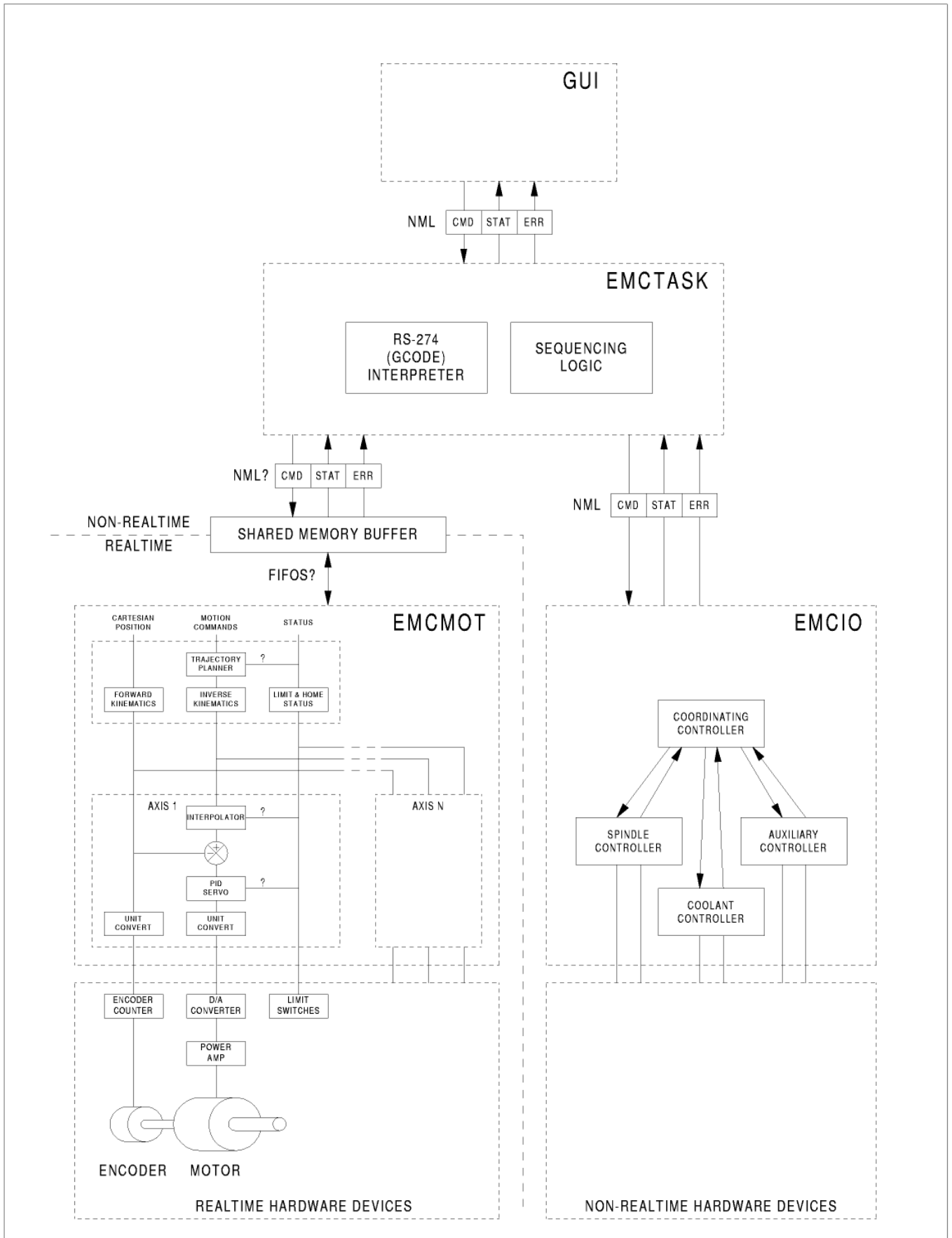

### 3.4.1 LinuxCNC software architecture

At the coarsest level, LinuxCNC is a hierarchy of three controllers: the task level command handler and program interpreter, the motion controller, and the discrete I/O controller. The discrete I/O controller is implemented as a hierarchy of controllers, in this case for spindle, coolant, and auxiliary (e.g., estop) subsystems. The task controller coordinates the actions of the motion and discrete I/O controllers. Their actions are programmed in conventional numerical control "G and M code" programs, which are interpreted by the task controller into NML messages and sent to the motion.

## 3.5 Motion Controller Introduction

The motion controller is a realtime component. It receives motion control commands from the non-realtime parts of LinuxCNC (i.e. the G-code interpreter/Task, GUIs, etc) and executes those commands within its realtime context. The communication from non-realtime context to realtime context happens via a message-passing IPC mechanism using shared memory, and via the Hardware Abstraction Layer (HAL).

The status of the motion controller is made available to the rest of LinuxCNC through the same message-passing shared memory IPC, and through HAL.

The motion controller interacts with the motor controllers and other realtime and non-realtime hardware using HAL.

This document assumes that the reader has a basic understanding of the HAL, and uses terms like HAL pins, HAL signals, etc, without explaining them. For more information about the HAL, see the HAL Manual. Another chapter of this document will eventually go into the internals of the HAL itself, but in this chapter, we only use the HAL API as defined in `src/hal/hal.h`.

### 3.5.1 Motion Controller Modules

The realtime functions of the motion controller are implemented with realtime modules — userspace shared objects for Preempt-RT systems or kernel modules for some kernel-mode realtime implementations such as RTAI:

- *tpmod* - trajectory planning
- *homemod* - homing functions
- *motmod* - processes NML commands and controls hardware via HAL
- *kinematics module* - performs forward (joints-->coordinates) and inverse (coordinates->joints) kinematics calculations

LinuxCNC is started by a **linuxcnc** script which reads a configuration INI file and starts all needed processes. For realtime motion control, the script first loads the default *tpmod* and *homemod* modules and then loads the kinematics and motion modules according to settings in *halfiles* specified by the INI file.

Custom (user-built) homing or trajectory-planning modules can be used in place of the default modules via INI file settings or command line options. Custom modules must implement all functions used by the default modules. The *halcompile* utility can be used to create a custom module.

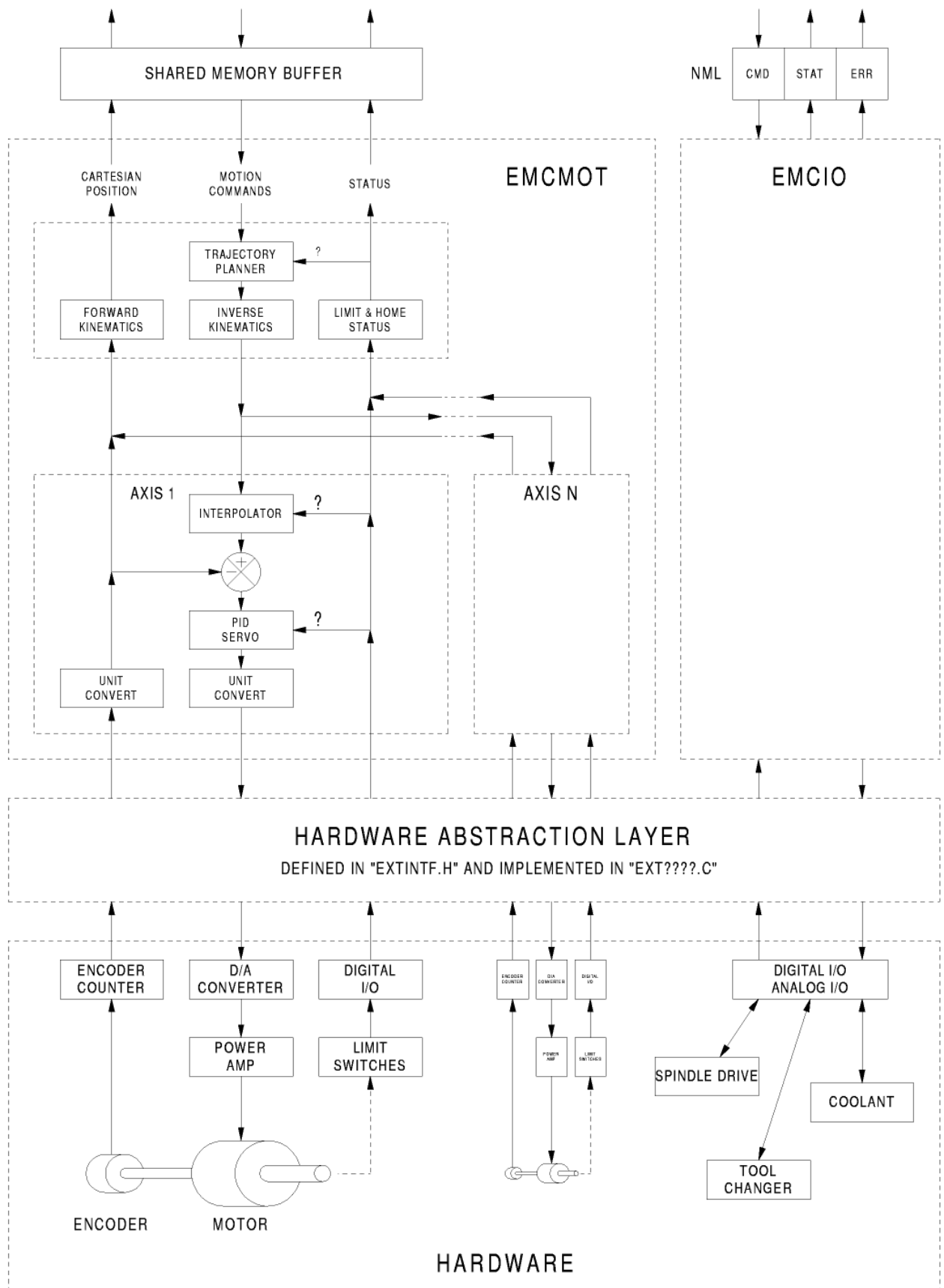



### 3.6 Block diagrams and Data Flow

The following figure is a block diagram of a joint controller. There is one joint controller per joint. The joint controllers work at a lower level than the kinematics, a level where all joints are completely independent. All the data for a joint is in a single joint structure. Some members of that structure are visible in the block diagram, such as `coarse_pos`, `pos_cmd`, and `motor_pos_fb`.

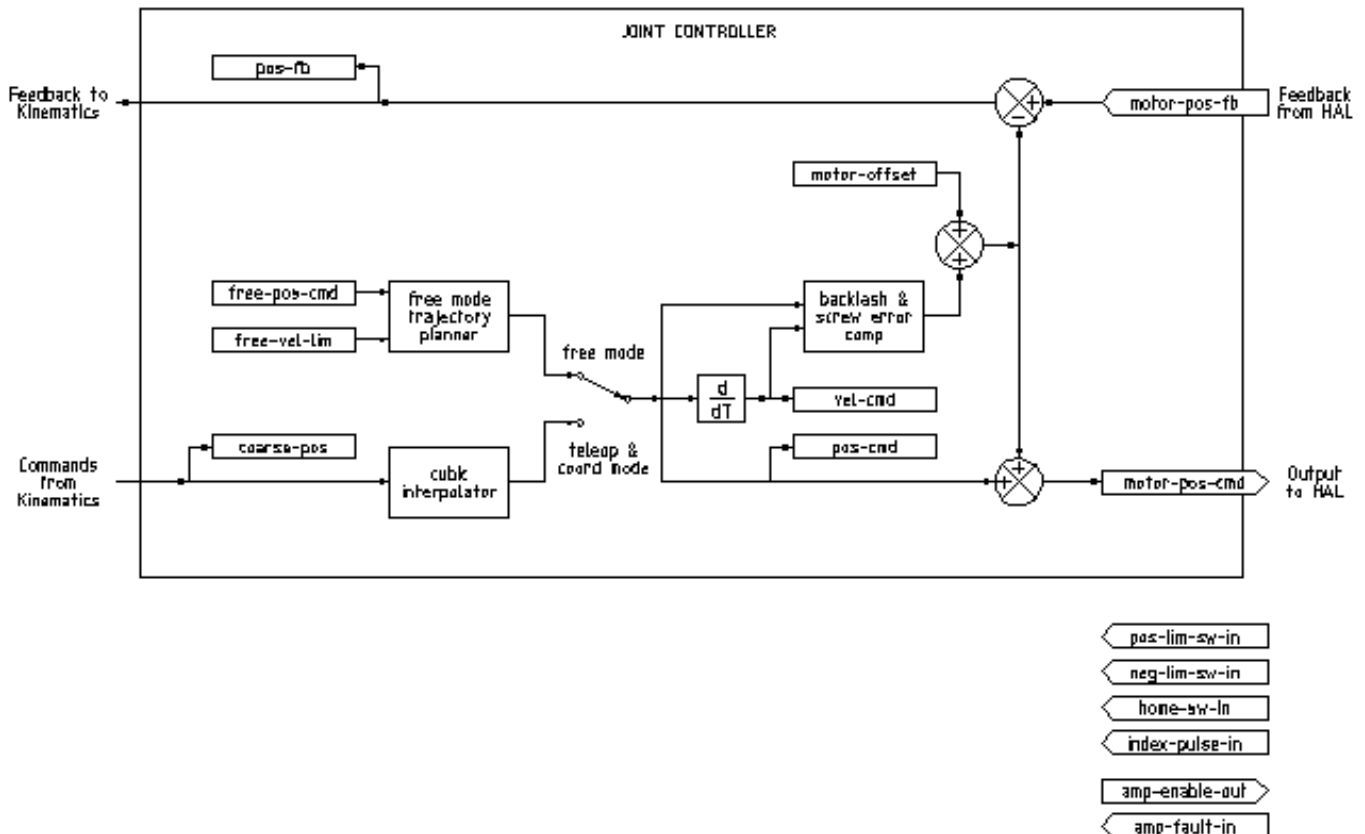

Figure 3.1: Joint Controller Block Diagram

The above figure shows five of the seven sets of position information that form the main data flow through the motion controller. The seven forms of position data are as follows:

- `emcmotStatus->carte_pos_cmd` - This is the desired position, in Cartesian coordinates. It is updated at the traj rate, not the servo rate. In coord mode, it is determined by the traj planner. In teleop mode, it is determined by the traj planner? In free mode, it is either copied from actualPos, or generated by applying forward kins to (2) or (3).
- `emcmotStatus->joints[n].coarse_pos` - This is the desired position, in joint coordinates, but before interpolation. It is updated at the traj rate, not the servo rate. In coord mode, it is generated by applying inverse kins to (1) In teleop mode, it is generated by applying inverse kins to (1) In free mode, it is copied from (3), I think.

- `'emcmotStatus->joints[n].pos_cmd` - This is the desired position, in joint coords, after interpolation. A new set of these coords is generated every servo period. In coord mode, it is generated from (2) by the interpolator. In teleop mode, it is generated from (2) by the interpolator. In free mode, it is generated by the free mode traj planner.
  - `emcmotStatus->joints[n].motor_pos_cmd` - This is the desired position, in motor coords. Motor coords are generated by adding backlash compensation, lead screw error compensation, and offset (for homing) to (3). It is generated the same way regardless of the mode, and is the output to the PID loop or other position loop.
  - `emcmotStatus->joints[n].motor_pos_fb` - This is the actual position, in motor coords. It is the input from encoders or other feedback device (or from virtual encoders on open loop machines). It is "generated" by reading the feedback device.
  - `emcmotStatus->joints[n].pos_fb` - This is the actual position, in joint coordinates. It is generated by subtracting offset, lead screw error compensation, and backlash compensation from (5). It is generated the same way regardless of the operating mode.
  - `emcmotStatus->carte_pos_fb` - This is the actual position, in Cartesian coordinates. It is updated at the traj rate, not the servo rate. Ideally, actualPos would always be calculated by applying forward kinematics to (6). However, forward kinematics may not be available, or they may be unusable because one or more axes aren't homed. In that case, the options are: A) fake it by copying (1), or B) admit that we don't really know the Cartesian coordinates, and simply don't update actualPos. Whatever approach is used, I can see no reason not to do it the same way regardless of the operating mode. I would propose the following: If there are forward kins, use them, unless they don't work because of unhomed axes or other problems, in which case do (B). If no forward kins, do (A), since otherwise actualPos would *never* get updated.
-



### 3.7 Homing

#### 3.7.1 Homing state diagram

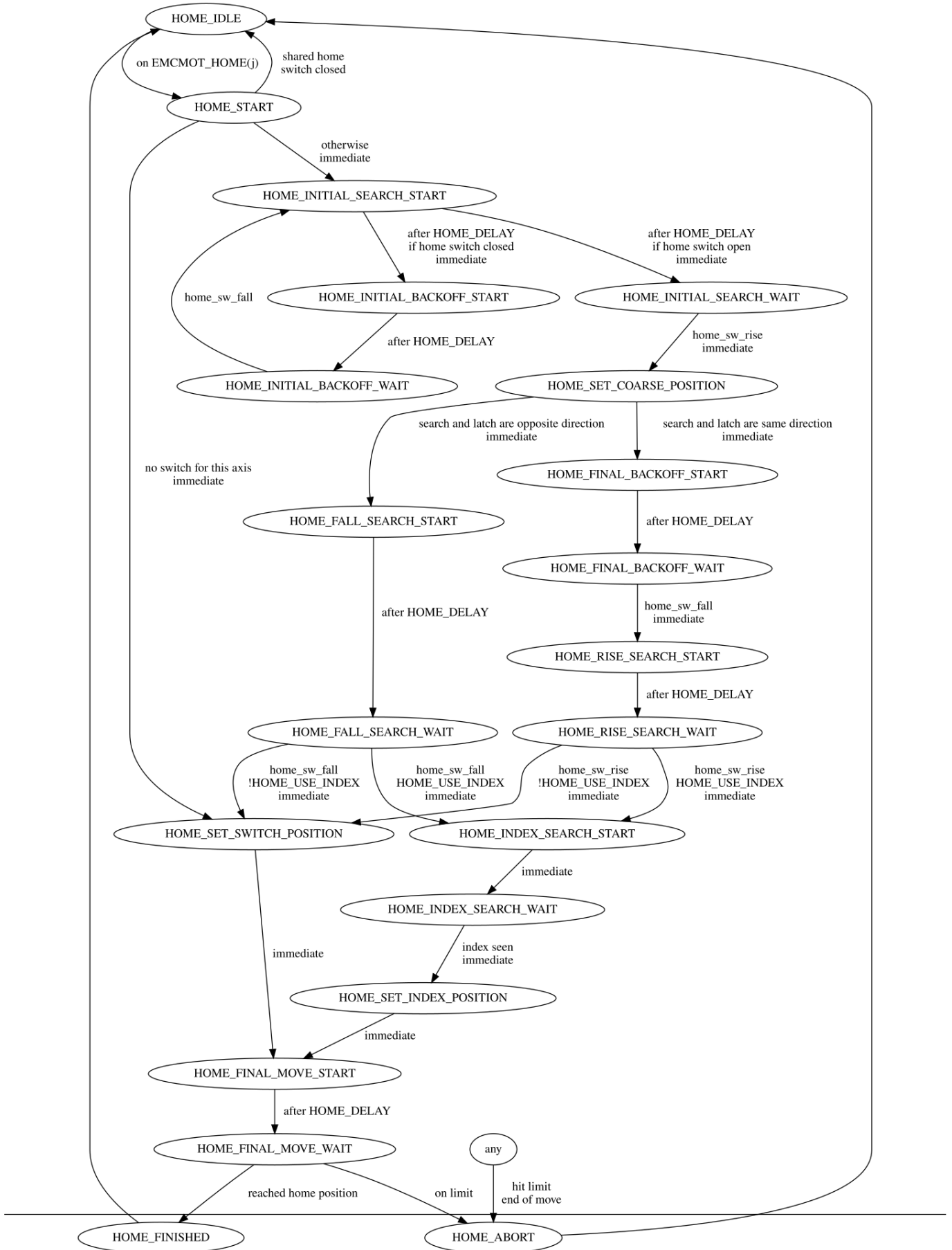

### 3.7.2 Another homing diagram

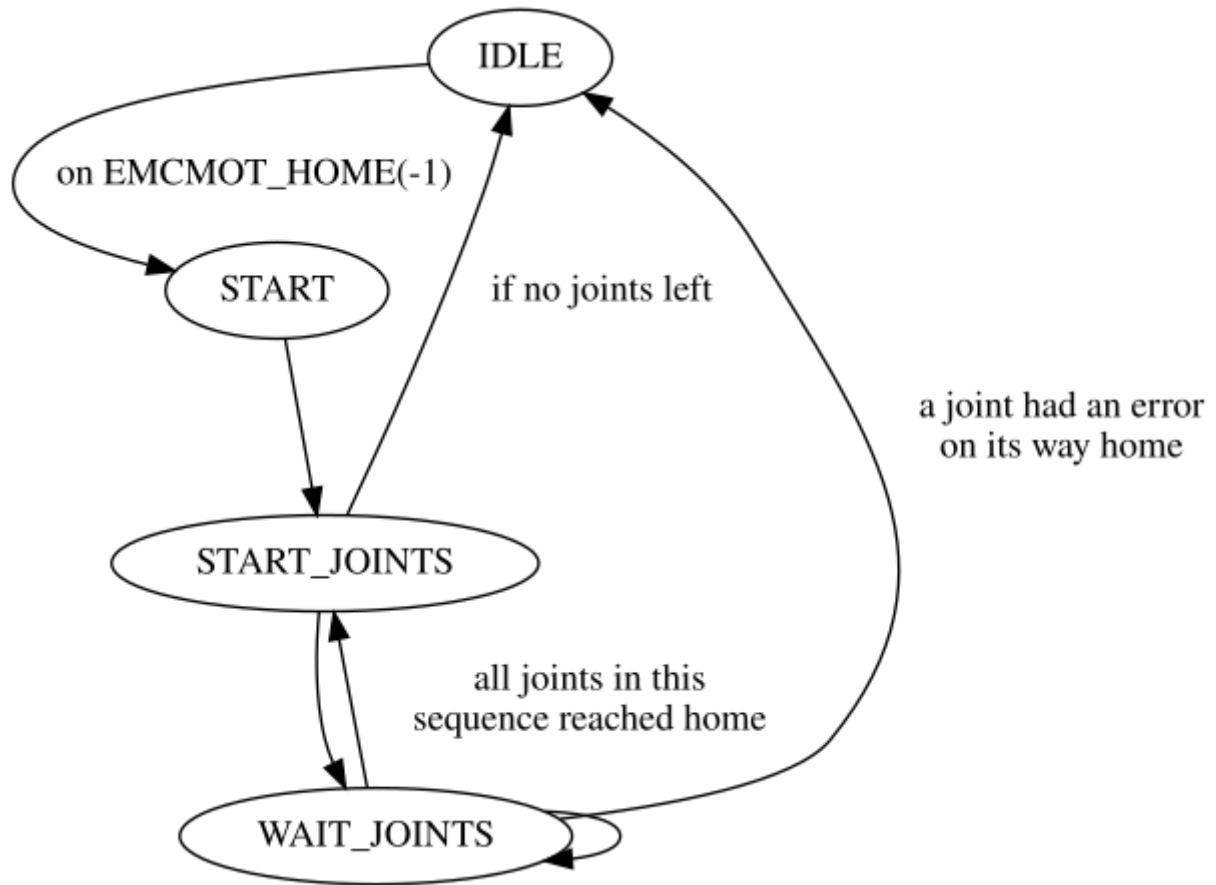

## 3.8 Commands

The commands are implemented by a large switch statement in the function `emcmotCommandHandler()`, which is called at the servo rate. More on that function later.

There are approximately 44 commands - this list is still under construction.

---

□□

The `cmd_code_t` enumeration, in `motion.h`, contains 73 commands, but the switch statement in `command.c` contemplates only 70 commands (as of 6/5/2020). `ENABLE_WATCHDOG` / `DISABLE_WATCHDOG` commands are in `motion-logger.c`. Maybe they are obsolete. The `SET_TELEOP_VECTOR` command only appears in `motion-logger.c`, with no effect other than its own log.

---

### 3.8.1 ABORT

The ABORT command simply stops all motion. It can be issued at any time, and will always be accepted. It does not disable the motion controller or change any state information, it simply cancels any motion that is currently in progress.<sup>1</sup>

<sup>1</sup>It seems that the higher level code (TASK and above) also use ABORT to clear faults. Whenever there is a persistent fault (such as being outside the hardware limit switches), the higher level code sends a constant stream of ABORTs to the motion controller trying to make the fault go away. Thousands of them.... That means that the motion controller should avoid persistent faults. This needs to be looked into.

---

### 3.8.1.1 Requirements

None. The command is always accepted and acted on immediately.

### 3.8.1.2 Results

In free mode, the free mode trajectory planners are disabled. That results in each joint stopping as fast as its accel (decel) limit allows. The stop is not coordinated. In teleop mode, the commanded Cartesian velocity is set to zero. I don't know exactly what kind of stop results (coordinated, uncoordinated, etc), but will figure it out eventually. In coord mode, the coord mode trajectory planner is told to abort the current move. Again, I don't know the exact result of this, but will document it when I figure it out.

## 3.8.2 FREE

The FREE command puts the motion controller in free mode. Free mode means that each joint is independent of all the other joints. Cartesian coordinates, poses, and kinematics are ignored when in free mode. In essence, each joint has its own simple trajectory planner, and each joint completely ignores the other joints. Some commands (like Joint JOG and HOME) only work in free mode. Other commands, including anything that deals with Cartesian coordinates, do not work at all in free mode.

### 3.8.2.1 Requirements

The command handler applies no requirements to the FREE command, it will always be accepted. However, if any joint is in motion (`GET_MOTION_INPOS_FLAG() == FALSE`), then the command will be ignored. This behavior is controlled by code that is now located in the function `set_operating_mode()` in `control.c`, that code needs to be cleaned up. I believe the command should not be silently ignored, instead the command handler should determine whether it can be executed and return an error if it cannot.

### 3.8.2.2 Results

If the machine is already in free mode, nothing. Otherwise, the machine is placed in free mode. Each joint's free mode trajectory planner is initialized to the current location of the joint, but the planners are not enabled and the joints are stationary.

## 3.8.3 TELEOP

The TELEOP command places the machine in teleoperating mode. In teleop mode, movement of the machine is based on Cartesian coordinates using kinematics, rather than on individual joints as in free mode. However the trajectory planner per se is not used, instead movement is controlled by a velocity vector. Movement in teleop mode is much like jogging, except that it is done in Cartesian space instead of joint space. On a machine with trivial kinematics, there is little difference between teleop mode and free mode, and GUIs for those machines might never even issue this command. However for non-trivial machines like robots and hexapods, teleop mode is used for most user commanded jog type movements.

### 3.8.3.1 Requirements

The command handler will reject the TELEOP command with an error message if the kinematics cannot be activated because the one or more joints have not been homed. In addition, if any joint is in motion (`GET_MOTION_INPOS_FLAG() == FALSE`), then the command will be ignored (with no error message). This behavior is controlled by code that is now located in the function `set_operating_mode()` in `control.c`. I believe the command should not be silently ignored, instead the command handler should determine whether it can be executed and return an error if it cannot.

### 3.8.3.2 Results

If the machine is already in teleop mode, nothing. Otherwise the machine is placed in teleop mode. The kinematics code is activated, interpolators are drained and flushed, and the Cartesian velocity commands are set to zero.

## 3.8.4 COORD

The COORD command places the machine in coordinated mode. In coord mode, movement of the machine is based on Cartesian coordinates using kinematics, rather than on individual joints as in free mode. In addition, the main trajectory planner is used to generate motion, based on queued LINE, CIRCLE, and/or PROBE commands. Coord mode is the mode that is used when executing a G-code program.

### 3.8.4.1 Requirements

The command handler will reject the COORD command with an error message if the kinematics cannot be activated because the one or more joints have not been homed. In addition, if any joint is in motion (`GET_MOTION_INPOS_FLAG() == FALSE`), then the command will be ignored (with no error message). This behavior is controlled by code that is now located in the function `set_operating_mode()` in `control.c`. I believe the command should not be silently ignored, instead the command handler should determine whether it can be executed and return an error if it cannot.

### 3.8.4.2 Results

If the machine is already in coord mode, nothing. Otherwise, the machine is placed in coord mode. The kinematics code is activated, interpolators are drained and flushed, and the trajectory planner queues are empty. The trajectory planner is active and awaiting a LINE, CIRCLE, or PROBE command.

## 3.8.5 ENABLE

The ENABLE command enables the motion controller.

### 3.8.5.1 Requirements

None. The command can be issued at any time, and will always be accepted.

### 3.8.5.2 Results

If the controller is already enabled, nothing. If not, the controller is enabled. Queues and interpolators are flushed. Any movement or homing operations are terminated. The amp-enable outputs associated with active joints are turned on. If forward kinematics are not available, the machine is switched to free mode.

---

### 3.8.6 DISABLE

The DISABLE command disables the motion controller.

#### 3.8.6.1 Requirements

None. The command can be issued at any time, and will always be accepted.

#### 3.8.6.2 Results

If the controller is already disabled, nothing. If not, the controller is disabled. Queues and interpolators are flushed. Any movement or homing operations are terminated. The amp-enable outputs associated with active joints are turned off. If forward kinematics are not available, the machine is switched to free mode.

### 3.8.7 ENABLE\_AMPLIFIER

The ENABLE\_AMPLIFIER command turns on the amp enable output for a single output amplifier, without changing anything else. Can be used to enable a spindle speed controller.

#### 3.8.7.1 Requirements

None. The command can be issued at any time, and will always be accepted.

#### 3.8.7.2 Results

Currently, nothing. (A call to the old extAmpEnable function is currently commented out.) Eventually it will set the amp enable HAL pin true.

### 3.8.8 DISABLE\_AMPLIFIER

The DISABLE\_AMPLIFIER command turns off the amp enable output for a single amplifier, without changing anything else. Again, useful for spindle speed controllers.

#### 3.8.8.1 Requirements

None. The command can be issued at any time, and will always be accepted.

#### 3.8.8.2 Results

Currently, nothing. (A call to the old extAmpEnable function is currently commented out.) Eventually it will set the amp enable HAL pin false.

### 3.8.9 ACTIVATE\_JOINT

The ACTIVATE\_JOINT command turns on all the calculations associated with a single joint, but does not change the joint's amp enable output pin.

---



### 3.8.9.1 Requirements

None. The command can be issued at any time, and will always be accepted.

### 3.8.9.2 Results

Calculations for the specified joint are enabled. The amp enable pin is not changed, however, any subsequent ENABLE or DISABLE commands will modify the joint's amp enable pin.

## 3.8.10 DEACTIVATE\_JOINT

The DEACTIVATE\_JOINT command turns off all the calculations associated with a single joint, but does not change the joint's amp enable output pin.

### 3.8.10.1 Requirements

None. The command can be issued at any time, and will always be accepted.

### 3.8.10.2 Results

Calculations for the specified joint are enabled. The amp enable pin is not changed, and subsequent ENABLE or DISABLE commands will not modify the joint's amp enable pin.

## 3.8.11 ENABLE\_WATCHDOG

The ENABLE\_WATCHDOG command enables a hardware based watchdog (if present).

### 3.8.11.1 Requirements

None. The command can be issued at any time, and will always be accepted.

### 3.8.11.2 Results

Currently nothing. The old watchdog was a strange thing that used a specific sound card. A new watchdog interface may be designed in the future.

## 3.8.12 DISABLE\_WATCHDOG

The DISABLE\_WATCHDOG command disables a hardware based watchdog (if present).

### 3.8.12.1 Requirements

None. The command can be issued at any time, and will always be accepted.

### 3.8.12.2 Results

Currently nothing. The old watchdog was a strange thing that used a specific sound card. A new watchdog interface may be designed in the future.

---

### **3.8.13 PAUSE**

The PAUSE command stops the trajectory planner. It has no effect in free or teleop mode. At this point I don't know if it pauses all motion immediately, or if it completes the current move and then pauses before pulling another move from the queue.

#### **3.8.13.1 Requirements**

None. The command can be issued at any time, and will always be accepted.

#### **3.8.13.2 Results**

The trajectory planner pauses.

### **3.8.14 RESUME**

The RESUME command restarts the trajectory planner if it is paused. It has no effect in free or teleop mode, or if the planner is not paused.

#### **3.8.14.1 Requirements**

None. The command can be issued at any time, and will always be accepted.

#### **3.8.14.2 Results**

The trajectory planner resumes.

### **3.8.15 STEP**

The STEP command restarts the trajectory planner if it is paused, and tells the planner to stop again when it reaches a specific point. It has no effect in free or teleop mode. At this point I don't know exactly how this works. I'll add more documentation here when I dig deeper into the trajectory planner.

#### **3.8.15.1 Requirements**

None. The command can be issued at any time, and will always be accepted.

#### **3.8.15.2 Results**

The trajectory planner resumes, and later pauses when it reaches a specific point.

### **3.8.16 SCALE**

The SCALE command scales all velocity limits and commands by a specified amount. It is used to implement feed rate override and other similar functions. The scaling works in free, teleop, and coord modes, and affects everything, including homing velocities, etc. However, individual joint velocity limits are unaffected.

---

### 3.8.16.1 Requirements

None. The command can be issued at any time, and will always be accepted.

### 3.8.16.2 Results

All velocity commands are scaled by the specified constant.

## 3.8.17 OVERRIDE\_LIMITS

The `OVERRIDE_LIMITS` command prevents limits from tripping until the end of the next JOG command. It is normally used to allow a machine to be jogged off of a limit switch after tripping. (The command can actually be used to override limits, or to cancel a previous override.)

### 3.8.17.1 Requirements

None. The command can be issued at any time, and will always be accepted. (I think it should only work in free mode.)

### 3.8.17.2 Results

Limits on all joints are over-ridden until the end of the next JOG command. (This is currently broken... once an `OVERRIDE_LIMITS` command is received, limits are ignored until another `OVERRIDE_LIMITS` command re-enables them.)

## 3.8.18 HOME

The `HOME` command initiates a homing sequence on a specified joint. The actual homing sequence is determined by a number of configuration parameters, and can range from simply setting the current position to zero, to a multi-stage search for a home switch and index pulse, followed by a move to an arbitrary home location. For more information about the homing sequence, see the homing section of the Integrator Manual.

### 3.8.18.1 Requirements

The command will be ignored silently unless the machine is in free mode.

### 3.8.18.2 Results

Any jog or other joint motion is aborted, and the homing sequence starts.

## 3.8.19 JOG\_CONT

The `JOG_CONT` command initiates a continuous jog on a single joint. A continuous jog is generated by setting the free mode trajectory planner's target position to a point beyond the end of the joint's range of travel. This ensures that the planner will move constantly until it is stopped by either the joint limits or an `ABORT` command. Normally, a GUI sends a `JOG_CONT` command when the user presses a jog button, and `ABORT` when the button is released.

---

### 3.8.19.1 Requirements

The command handler will reject the JOG\_CONT command with an error message if machine is not in free mode, or if any joint is in motion (`GET_MOTION_INPOS_FLAG() == FALSE`), or if motion is not enabled. It will also silently ignore the command if the joint is already at or beyond its limit and the commanded jog would make it worse.

### 3.8.19.2 Results

The free mode trajectory planner for the joint identified by `emcmotCommand->axis` is activated, with a target position beyond the end of joint travel, and a velocity limit of `emcmotCommand->vel`. This starts the joint moving, and the move will continue until stopped by an ABORT command or by hitting a limit. The free mode planner accelerates at the joint accel limit at the beginning of the move, and will decelerate at the joint accel limit when it stops.

## 3.8.20 JOG\_INCR

The JOG\_INCR command initiates an incremental jog on a single joint. Incremental jogs are cumulative, in other words, issuing two JOG\_INCR commands that each ask for 0.100 inches of movement will result in 0.200 inches of travel, even if the second command is issued before the first one finishes. Normally incremental jogs stop when they have traveled the desired distance, however they also stop when they hit a limit, or on an ABORT command.

### 3.8.20.1 Requirements

The command handler will silently reject the JOG\_INCR command if machine is not in free mode, or if any joint is in motion (`GET_MOTION_INPOS_FLAG() == FALSE`), or if motion is not enabled. It will also silently ignore the command if the joint is already at or beyond its limit and the commanded jog would make it worse.

### 3.8.20.2 Results

The free mode trajectory planner for the joint identified by `emcmotCommand->axis` is activated, the target position is incremented/decremented by `emcmotCommand->offset`, and the velocity limit is set to `emcmotCommand->vel`. The free mode trajectory planner will generate a smooth trapezoidal move from the present position to the target position. The planner can correctly handle changes in the target position that happen while the move is in progress, so multiple JOG\_INCR commands can be issued in quick succession. The free mode planner accelerates at the joint accel limit at the beginning of the move, and will decelerate at the joint accel limit to stop at the target position.

## 3.8.21 JOG\_ABS

The JOG\_ABS command initiates an absolute jog on a single joint. An absolute jog is a simple move to a specific location, in joint coordinates. Normally absolute jogs stop when they reach the desired location, however they also stop when they hit a limit, or on an ABORT command.

### 3.8.21.1 Requirements

The command handler will silently reject the JOG\_ABS command if machine is not in free mode, or if any joint is in motion (`GET_MOTION_INPOS_FLAG() == FALSE`), or if motion is not enabled. It will also silently ignore the command if the joint is already at or beyond its limit and the commanded jog would make it worse.

---

### 3.8.21.2 Results

The free mode trajectory planner for the joint identified by `emcmotCommand->axis` is activated, the target position is set to `emcmotCommand->offset`, and the velocity limit is set to `emcmotCommand->vel`. The free mode trajectory planner will generate a smooth trapezoidal move from the present position to the target position. The planner can correctly handle changes in the target position that happen while the move is in progress. If multiple JOG\_ABS commands are issued in quick succession, each new command changes the target position and the machine goes to the final commanded position. The free mode planner accelerates at the joint accel limit at the beginning of the move, and will decelerate at the joint accel limit to stop at the target position.

### 3.8.22 SET\_LINE

The SET\_LINE command adds a straight line to the trajectory planner queue.

(More later)

### 3.8.23 SET\_CIRCLE

The SET\_CIRCLE command adds a circular move to the trajectory planner queue.

(More later)

### 3.8.24 SET\_TELEOP\_VECTOR

The SET\_TELEOP\_VECTOR command instructs the motion controller to move along a specific vector in Cartesian space.

(More later)

### 3.8.25 PROBE

The PROBE command instructs the motion controller to move toward a specific point in Cartesian space, stopping and recording its position if the probe input is triggered.

(More later)

### 3.8.26 CLEAR\_PROBE\_FLAG

The CLEAR\_PROBE\_FLAG command is used to reset the probe input in preparation for a PROBE command. (Question: why shouldn't the PROBE command automatically reset the input?)

(More later)

### 3.8.27 SET\_xix

There are approximately 15 SET\_xxx commands, where xxx is the name of some configuration parameter. It is anticipated that there will be several more SET commands as more parameters are added. I would like to find a cleaner way of setting and reading configuration parameters. The existing methods require many lines of code to be added to multiple files each time a parameter is added. Much of that code is identical or nearly identical for every parameter.

### 3.9 Backlash and Screw Error Compensation

+ FIXME Backlash and Screw Error Compensation

### 3.10 Task controller (EMCTASK)

#### 3.10.1 State

Task has three possible internal states: **E-stop**, **E-stop Reset**, and **Machine On**.

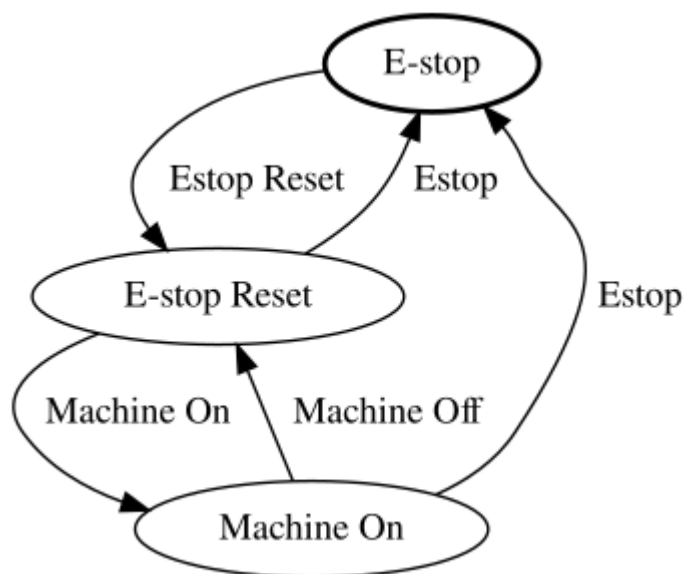

### 3.11 IO controller (EMCIO)

The I/O Controller is part of TASK. It interacts with external I/O using HAL pins.

Currently ESTOP/Enable, coolant, and tool changing are handled by iocontrol. These are relatively low speed events, high speed coordinated I/O is handled in motion.

emctaskmain.cc sends I/O commands via taskclass.cc.

iocontrol main loop process:

- checks to see if HAL inputs have changed
- checks if read\_tool\_inputs() indicates the tool change is finished and set emcioStatus.status

### 3.12 □□□□

FIXME User Interfaces

### 3.13 libnml Introduction

libnml is derived from the NIST rcslib without all the multi-platform support. Many of the wrappers around platform specific code has been removed along with much of the code that is not required by LinuxCNC. It is hoped that sufficient compatibility remains with rcslib so that applications can be implemented on non-Linux platforms and still be able to communicate with LinuxCNC.

This chapter is not intended to be a definitive guide to using libnml (or rcslib), instead, it will eventually provide an overview of each C++ class and their member functions. Initially, most of these notes will be random comments added as the code scrutinized and modified.

### 3.14 LinkedList

Base class to maintain a linked list. This is one of the core building blocks used in passing NML messages and assorted internal data structures.

### 3.15 LinkedListNode

Base class for producing a linked list - Purpose, to hold pointers to the previous and next nodes, pointer to the data, and the size of the data.

No memory for data storage is allocated.

### 3.16 SharedMemory

Provides a block of shared memory along with a semaphore (inherited from the Semaphore class). Creation and destruction of the semaphore is handled by the SharedMemory constructor and destructor.

### 3.17 ShmBuffer

Class for passing NML messages between local processes using a shared memory buffer. Much of internal workings are inherited from the CMS class.

### 3.18 Timer

The Timer class provides a periodic timer limited only by the resolution of the system clock. If, for example, a process needs to be run every 5 seconds regardless of the time taken to run the process, the following code snippet demonstrates how :

```
main()
{
    timer = new Timer(5.0);    /* Initialize a timer with a 5 second loop */
    while(0) {
        /* Do some process */
        timer.wait();        /* Wait till the next 5 second interval */
    }
    delete timer;
}
```

## 3.19 Semaphore

The Semaphore class provides a method of mutual exclusions for accessing a shared resource. The function to get a semaphore can either block until access is available, return after a timeout, or return immediately with or without gaining the semaphore. The constructor will create a semaphore or attach to an existing one if the ID is already in use.

The Semaphore::destroy() must be called by the last process only.

## 3.20 CMS

At the heart of libnml is the CMS class, it contains most of the functions used by libnml and ultimately NML. Many of the internal functions are overloaded to allow for specific hardware dependent methods of data passing. Ultimately, everything revolves around a central block of memory (referred to as the *message buffer* or just *buffer*). This buffer may exist as a shared memory block accessed by other CMS/NML processes, or a local and private buffer for data being transferred by network or serial interfaces.

The buffer is dynamically allocated at run time to allow for greater flexibility of the CMS/NML subsystem. The buffer size must be large enough to accommodate the largest message, a small amount for internal use and allow for the message to be encoded if this option is chosen (encoded data will be covered later). The following figure is an internal view of the buffer space.



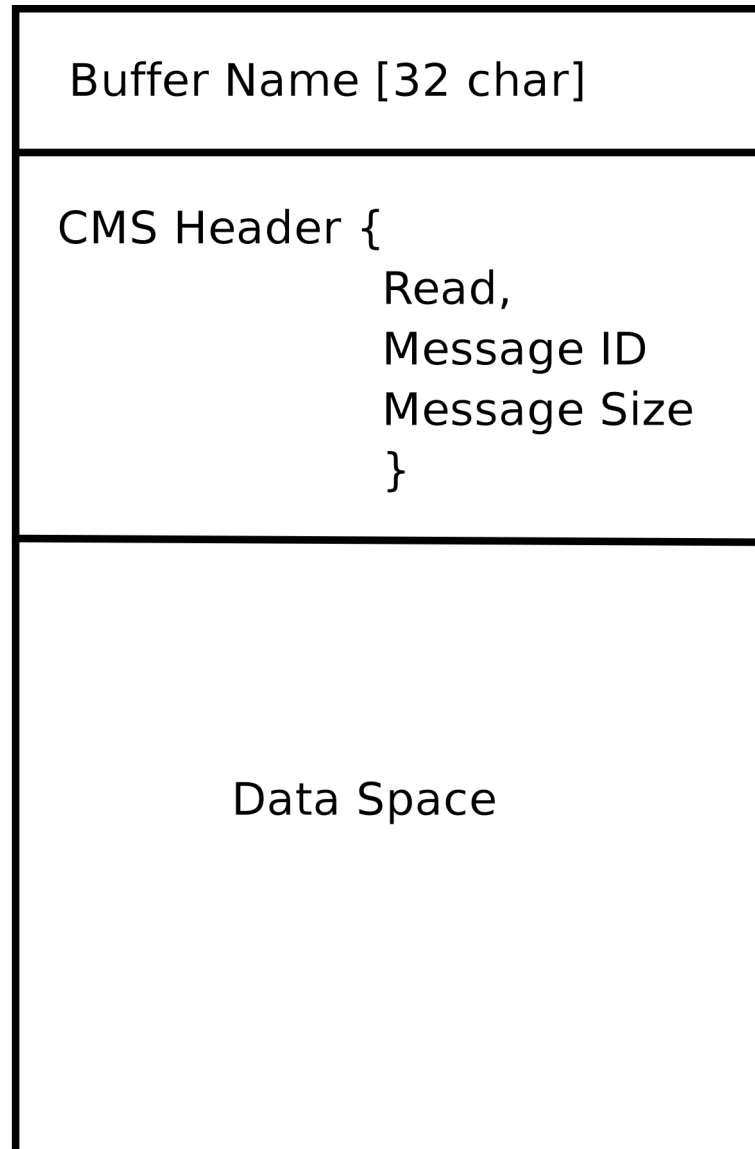

**CMS buffer** The CMS base class is primarily responsible for creating the communications pathways and interfacing to the operating system.

### 3.21 Configuration file format

NML configuration consists of two types of line formats. One for Buffers, and a second for Processes that connect to the buffers.

#### 3.21.1 Buffer line

The original NIST format of the buffer line is:

- *B name type host size neut RPC# buffer# max\_procs key [type specific configs]*
- *B* - identifies this line as a Buffer configuration.
- *name* - is the identifier of the buffer.

- *type* - describes the buffer type - SHMEM, LOCMEM, FILEMEM, PHANTOM, or GLOBMEM.
- *host* - is either an IP address or host name for the NML server
- *size* - is the size of the buffer
- *neut* - a boolean to indicate if the data in the buffer is encoded in a machine independent format, or raw.
- *RPC#* - Obsolete - Place holder retained for backward compatibility only.
- *buffer#* - A unique ID number used if a server controls multiple buffers.
- *max\_procs* - is the maximum processes allowed to connect to this buffer.
- *key* - is a numerical identifier for a shared memory buffer

### 3.21.2 Type specific configs

The buffer type implies additional configuration options whilst the host operating system precludes certain combinations. In an attempt to distill published documentation in to a coherent format, only the **SHMEM** buffer type will be covered.

- *mutex=os\_sem* - default mode for providing semaphore locking of the buffer memory.
  - *mutex=none* - Not used
  - *mutex=no\_interrupts* - not applicable on a Linux system
  - *mutex=no\_switching* - not applicable on a Linux system
  - *mutex=mao\_split* - Splits the buffer in to half (or more) and allows one process to access part of the buffer whilst a second process is writing to another part.
  - *TCP=(port number)* - Specifies which network port to use.
  - *UDP=(port number)* - ditto
  - *STCP=(port number)* - ditto
  - *serialPortDevName=(serial port)* - Undocumented.
  - *passwd=file\_name.pwd* - Adds a layer of security to the buffer by requiring each process to provide a password.
  - *bsem* - NIST documentation implies a key for a blocking semaphore, and if *bsem=-1*, blocking reads are prevented.
  - *queue* - Enables queued message passing.
  - *ascii* - Encode messages in a plain text format
  - *disp* - Encode messages in a format suitable for display (???)
  - *xdr* - Encode messages in External Data Representation. (see `rpc/xdr.h` for details).
  - *diag* - Enables diagnostics stored in the buffer (timings and byte counts ?)
-

### 3.21.3 Process line

The original NIST format of the process line is:

**P name buffer type host ops server timeout master c\_num [type specific configs]**

- *P* - identifies this line as a Process configuration.
- *name* - is the identifier of the process.
- *buffer* - is one of the buffers defined elsewhere in the config file.
- *type* - defines whether this process is local or remote relative to the buffer.
- *host* - specifies where on the network this process is running.
- *ops* - gives the process read only, write only, or read/write access to the buffer.
- *server* - specifies if this process will running a server for this buffer.
- *timeout* - sets the timeout characteristics for accesses to the buffer.
- *master* - indicates if this process is responsible for creating and destroying the buffer.
- *c\_num* - an integer between zero and (max\_procs -1)

### 3.21.4 Configuration Comments

Some of the configuration combinations are invalid, whilst others imply certain constraints. On a Linux system, GLOBMEM is obsolete, whilst PHANTOM is only really useful in the testing stage of an application, likewise for FILEMEM. LOCMEM is of little use for a multi-process application, and only offers limited performance advantages over SHMEM. This leaves SHMEM as the only buffer type to use with LinuxCNC.

The neut option is only of use in a multi-processor system where different (and incompatible) architectures are sharing a block of memory. The likelihood of seeing a system of this type outside of a museum or research establishment is remote and is only relevant to GLOBMEM buffers.

The RPC number is documented as being obsolete and is retained only for compatibility reasons.

With a unique buffer name, having a numerical identity seems to be pointless. Need to review the code to identify the logic. Likewise, the key field at first appears to be redundant, and it could be derived from the buffer name.

The purpose of limiting the number of processes allowed to connect to any one buffer is unclear from existing documentation and from the original source code. Allowing unspecified multiple processes to connect to a buffer is no more difficult to implement.

The mutex types boil down to one of two, the default "os\_sem" or "mao split". Most of the NML messages are relatively short and can be copied to or from the buffer with minimal delays, so split reads are not essential.

Data encoding is only relevant when transmitted to a remote process - Using TCP or UDP implies XDR encoding. Whilst ASCII encoding may have some use in diagnostics or for passing data to an embedded system that does not implement NML.

UDP protocols have fewer checks on data and allows a percentage of packets to be dropped. TCP is more reliable, but is marginally slower.

If LinuxCNC is to be connected to a network, one would hope that it is local and behind a firewall. About the only reason to allow access to LinuxCNC via the Internet would be for remote diagnostics - This can be achieved far more securely using other means, perhaps by a web interface.

The exact behavior when timeout is set to zero or a negative value is unclear from the NIST documents. Only INF and positive values are mentioned. However, buried in the source code of rcslib, it is apparent that the following applies:

timeout > 0 Blocking access until the timeout interval is reached or access to the buffer is available.

timeout = 0 Access to the buffer is only possible if no other process is reading or writing at the time.

timeout < 0 or INF Access is blocked until the buffer is available.

## 3.22 NML base class

Expand on the lists and the relationship between NML, NMLmsg, and the lower level cms classes.

Not to be confused with NMLmsg, RCS\_STAT\_MSG, or RCS\_CMD\_MSG.

NML is responsible for parsing the config file, configuring the cms buffers and is the mechanism for routing messages to the correct buffer(s). To do this, NML creates several lists for:

- cms buffers created or connected to.
- processes and the buffers they connect to
- a long list of format functions for each message type

This last item is probably the nub of much of the malignment of libnml/rcslib and NML in general. Each message that is passed via NML requires a certain amount of information to be attached in addition to the actual data. To do this, several formatting functions are called in sequence to assemble fragments of the overall message. The format functions will include NML\_TYPE, MSG\_TYPE, in addition to the data declared in derived NMLmsg classes. Changes to the order in which the formatting functions are called and also the variables passed will break compatibility with rcslib if messed with - There are reasons for maintaining rcslib compatibility, and good reasons for messing with the code. The question is, which set of reasons are overriding?

### 3.22.1 NML internals

#### 3.22.1.1 NML constructor

NML::NML() parses the config file and stores it in a linked list to be passed to cms constructors in single lines. It is the function of the NML constructor to call the relevant cms constructor for each buffer and maintain a list of the cms objects and the processes associated with each buffer.

It is from the pointers stored in the lists that NML can interact with cms and why Doxygen fails to show the real relationships involved.

---

□□

The config is stored in memory before passing a pointer to a specific line to the cms constructor. The cms constructor then parses the line again to extract a couple of variables... It would make more sense to do ALL the parsing and save the variables in a struct that is passed to the cms constructor - This would eliminate string handling and reduce duplicate code in cms...

---

### 3.22.1.2 NML read/write

Calls to `NML::read` and `NML::write` both perform similar tasks in so much as processing the message - The only real variation is in the direction of data flow.

A call to the read function first gets data from the buffer, then calls `format_output()`, whilst a write function would call `format_input()` before passing the data to the buffer. It is in `format_xxx()` that the work of constructing or deconstructing the message takes place. A list of assorted functions are called in turn to place various parts of the NML header (not to be confused with the cms header) in the right order - The last function called is `emcFormat()` in `emc.cc`.

### 3.22.1.3 NMLmsg and NML relationships

`NMLmsg` is the base class from which all message classes are derived. Each message class must have a unique ID defined (and passed to the constructor) and also an `update(*cms)` function. The `update()` will be called by the NML read/write functions when the NML formatter is called — the pointer to the formatter will have been declared in the NML constructor at some point. By virtue of the linked lists NML creates, it is able to select cms pointer that is passed to the formatter and therefor which buffer is to be used.

## 3.23 Adding custom NML commands

LinuxCNC is pretty awesome, but some parts need some tweaking. As you know communication is done through NML channels, the data sent through such a channel is one of the classes defined in `emc.hh` (implemented in `emc.cc`). If somebody needs a message type that doesn't exist, he should follow these steps to add a new one. (The Message I added in the example is called `EMC_IO_GENERIC` (inherits `EMC_IO_CMD_MSG` (inherits `RCS_CMD_MSG`)))

1. add the definition of the `EMC_IO_GENERIC` class to `emc2/src/emc/nml_intf/emc.hh`
2. add the type define: `#define EMC_IO_GENERIC_TYPE ((NMLTYPE) 1605)`
  - a. (I chose 1605, because it was available) to `emc2/src/emc/nml_intf/emc.hh`
3. add case `EMC_IO_GENERIC_TYPE` to `emcFormat` in `emc2/src/emc/nml_intf/emc.cc`
4. add case `EMC_IO_GENERIC_TYPE` to `emc_symbol_lookup` in `emc2/src/emc/nml_intf/emc.cc`
5. add `EMC_IO_GENERIC::update` function to `emc2/src/emc/nml_intf/emc.cc`

Recompile, and the new message should be there. The next part is to send such messages from somewhere, and receive them in another place, and do some stuff with it.

## 3.24 The Tool Table and Toolchanger

LinuxCNC interfaces with toolchanger hardware, and has an internal toolchanger abstraction. LinuxCNC manages tool information in a tool table file.

### 3.24.1 Toolchanger abstraction in LinuxCNC

LinuxCNC supports two kinds of toolchanger hardware, called *nonrandom* and *random*. The INI setting `[EMCIO]RANDOM_TOOLCHANGER` controls which of these kinds of hardware LinuxCNC thinks it is connected to.

---

### 3.24.1.1 Nonrandom Toolchangers

Nonrandom toolchanger hardware puts each tool back in the pocket it was originally loaded from.

Examples of nonrandom toolchanger hardware are the “manual” toolchanger, lathe tool turrets, and rack toolchangers.

When configured for a nonrandom toolchanger, LinuxCNC does not change the pocket number in the tool table file as tools are loaded and unloaded. Internal to LinuxCNC, on tool change the tool information is **copied** from the tool table’s source pocket to pocket 0 (which represents the spindle), replacing whatever tool information was previously there.

---

□□

In LinuxCNC configured for nonrandom toolchanger, tool 0 (T0) has special meaning: “no tool”. T0 may not appear in the tool table file, and changing to T0 will result in LinuxCNC thinking it has got an empty spindle.

---

### 3.24.1.2 Random Toolchangers

Random toolchanger hardware swaps the tool in the spindle (if any) with the requested tool on tool change. Thus the pocket that a tool resides in changes as it is swapped in and out of the spindle.

An example of random toolchanger hardware is a carousel toolchanger.

When configured for a random toolchanger, LinuxCNC swaps the pocket number of the old and the new tool in the tool table file when tools are loaded. Internal to LinuxCNC, on tool change, the tool information is **swapped** between the tool table’s source pocket and pocket 0 (which represents the spindle). So after a tool change, pocket 0 in the tool table has the tool information for the new tool, and the pocket that the new tool came from has the tool information for the old tool (the tool that was in the spindle before the tool change), if any.

---

□□

If LinuxCNC is configured for random toolchanger, tool 0 (T0) has **no** special meaning. It is treated exactly like any other tool in the tool table. It is customary to use T0 to represent “no tool” (i.e., a tool with zero TLO), so that the spindle can be conveniently emptied when needed.

---

## 3.24.2 The Tool Table

LinuxCNC keeps track of tools in a file called the [tool table](#). The tool table records the following information for each tool:

### tool number

An integer that uniquely identifies this tool. Tool numbers are handled differently by LinuxCNC when configured for random and nonrandom toolchangers:

- When LinuxCNC is configured for a nonrandom toolchanger this number must be positive. T0 gets special handling and is not allowed to appear in the tool table.
- When LinuxCNC is configured for a random toolchanger this number must be non-negative. T0 is allowed in the tool table, and is usually used to represent “no tool”, i.e. the empty pocket.

### pocket number

An integer that identifies the pocket or slot in the toolchanger hardware where the tool resides. Pocket numbers are handled differently by LinuxCNC when configured for random and nonrandom toolchangers:

---

- When LinuxCNC is configured for a nonrandom toolchanger, the pocket number in the tool file can be any positive integer (pocket 0 is not allowed). LinuxCNC silently compactifies the pocket numbers when it loads the tool file, so there may be a difference between the pocket numbers in the tool file and the internal pocket numbers used by LinuxCNC-with-nonrandom-toolchanger.
- When LinuxCNC is configured for a random toolchanger, the pocket numbers in the tool file must be between 0 and 1000, inclusive. Pockets 1-1000 are in the toolchanger, pocket 0 is the spindle.

**diameter**

Diameter of the tool, in machine units.

**tool length offset**

Tool length offset (also called TLO), in up to 9 axes, in machine units. Axes that don't have a specified TLO get 0.

**3.24.3 G-codes affecting tools**

The G-codes that use or affect tool information are:

**3.24.3.1 Txxx**

Tells the toolchanger hardware to prepare to switch to a specified tool xxx.

Handled by `Interp::convert_tool_select()`.

1. The machine is asked to prepare to switch to the selected tool by calling the Canon function `SELECT_TOOL()` with the tool number of the requested tool.
  - a. (saicanon) No-op.
  - b. (emccanon) Builds an `EMC_TOOL_PREPARE` message with the requested pocket number and sends it to Task, which sends it on to IO. IO gets the message and asks HAL to prepare the pocket by setting `iocontrol.0.tool-prep-pocket`, `iocontrol.0.tool-prep-number`, and `iocontrol.0.tool-prepare`. IO then repeatedly calls `read_tool_inputs()` to poll the HAL pin `iocontrol.0.tool-prepared`, which signals from the toolchanger hardware, via HAL, to IO that the requested tool prep is complete. When that pin goes True, IO sets `emcIOStatus.tool.pocketPrepped` to the requested tool's pocket number.
2. Back in `interp`, `settings->selected_pocket` is assigned the `tooldata` index of the requested tool xxx.

---

□□

The legacy names **selected\_pocket** and **current\_pocket** actually reference a sequential `tooldata` index for tool items loaded from a tool table (`[EMCIO]TOOL_TABLE`) or via a `tooldata` database (`[EMCIO]DB_PROGRAM`).

---

**3.24.3.2 M6**

Tells the toolchanger to switch to the currently selected tool (selected by the previous Txxx command).

Handled by `Interp::convert_tool_change()`.

1. The machine is asked to change to the selected tool by calling the Canon function `CHANGE_TOOL()` with `settings->selected_pocket` (a `tooldata` index).
-

- a. (saicanon) Sets sai's `_active_slot` to the passed-in pocket number. Tool information is copied from the selected pocket of of the tool table (ie, from sai's `_tools[_active_slot]`) to the spindle (aka sai's `_tools[0]`).
  - b. (emccanon) Sends an `EMC_TOOL_LOAD` message to Task, which sends it to IO. IO sets `emcioStatus.tool.pocketPrepped` to the tool number of the tool in the pocket identified by `emcioStatus.tool.pocketPrepped` (set by Txxx aka `SELECT_TOOL()`). It then requests that the toolchanger hardware perform a tool change, by setting the HAL pin `iocontrol.0.tool-change` to True. Later, IO's `read_tool_inputs()` will sense that the HAL pin `iocontrol.0.tool-changed` has been set to True, indicating the toolchanger has completed the tool change. When this happens, it calls `load_tool()` to update the machine state.
    - i. `load_tool()` with a nonrandom toolchanger config copies the tool information from the selected pocket to the spindle (pocket 0).
    - ii. `load_tool()` with a random toolchanger config swaps tool information between pocket 0 (the spindle) and the selected pocket, then saves the tool table.
2. Back in `interp`, `settings->current_pocket` is assigned the new `tooldata` index from `settings->select` (set by Txxx). The relevant numbered parameters ([#5400-#5413](#)) are updated with the new tool information from pocket 0 (spindle).

### 3.24.3.3 G43/G43.1/G49

Apply tool length offset. G43 uses the TLO of the currently loaded tool, or of a specified tool if the H-word is given in the block. G43.1 gets TLO from axis-words in the block. G49 cancels the TLO (it uses 0 for the offset for all axes).

Handled by `Interp::convert_tool_length_offset()`.

1. It starts by building an `EmcPose` containing the 9-axis offsets to use. For G43.1, these tool offsets come from axis words in the current block. For G43 these offsets come from the current tool (the tool in pocket 0), or from the tool specified by the H-word in the block. For G49, the offsets are all 0.
2. The offsets are passed to Canon's `USE_TOOL_LENGTH_OFFSET()` function.
  - a. (saicanon) Records the TLO in `_tool_offset`.
  - b. (emccanon) Builds an `EMC_TRAJ_SET_OFFSET` message containing the offsets and sends it to Task. Task copies the offsets to `emcStatus->task.toolOffset` and sends them on to Motion via an `EMCMOT_SET_OFFSET` command. Motion copies the offsets to `emcmotStatus->tool_offset`, where it gets used to offset future motions.
3. Back in `interp`, the offsets are recorded in `settings->tool_offset`. The effective pocket is recorded in `settings->tool_offset_index`, though this value is never used.

### 3.24.3.4 G10 L1/L10/L11

Modifies the tool table.

Handled by `Interp::convert_setup_tool()`.

1. Picks the tool number out of the P-word in the block and finds the pocket for that tool:
  - a. With a nonrandom toolchanger config this is always the pocket number in the toolchanger (even when the tool is in the spindle).
  - b. With a random toolchanger config, if the tool is currently loaded it uses pocket 0 (pocket 0 means "the spindle"), and if the tool is not loaded it uses the pocket number in the tool changer. (This difference is important.)



2. Figures out what the new offsets should be.
3. The new tool information (diameter, offsets, angles, and orientation), along with the tool number and pocket number, are passed to the Canon call SET\_TOOL\_TABLE\_ENTRY().
  - a. (saicanon) Copy the new tool information to the specified pocket (in sai's internal tool table, `_tools`).
  - b. (emccanon) Build an EMC\_T00L\_SET\_OFFSET message with the new tool information, and send it to Task, which passes it to IO. IO updates the specified pocket in its internal copy of the tool table (`emcioStatus.tool.toolTable`), and if the specified tool is currently loaded (it is compared to `emcioStatus.tool.toolInSpindle`) then the new tool information is copied to pocket 0 (the spindle) as well. (FIXME: that's a buglet, should only be copied on nonrandom machines.) Finally IO saves the new tool table.
4. Back in interp, if the modified tool is currently loaded in the spindle, and if the machine is a non-random toolchanger, then the new tool information is copied from the tool's home pocket to pocket 0 (the spindle) in interp's copy of the tool table, `settings->tool_table`. (This copy is not needed on random tool changer machines because there, tools don't have a home pocket and instead we just updated the tool in pocket 0 directly.). The relevant numbered parameters ([#5400-#5413](#)) are updated from the tool information in the spindle (by copying the information from interp's `settings->tool_table` to `settings->parameters`). (FIXME: this is a buglet, the params should only be updated if it was the current tool that was modified).
5. If the modified tool is currently loaded in the spindle, and if the config is for a nonrandom toolchanger, then the new tool information is written to the tool table's pocket 0 as well, via a second call to SET\_TOOL\_TABLE\_ENTRY(). (This second tool-table update is not needed on random toolchanger machines because there, tools don't have a home pocket and instead we just updated the tool in pocket 0 directly.)

### 3.24.3.5 M61

Set current tool number. This switches LinuxCNC's internal representation of which tool is in the spindle, without actually moving the toolchanger or swapping any tools.

Handled by `Interp::convert_tool_change()`.

Canon: `CHANGE_TOOL_NUMBER()`

`settings->current_pocket` is assigned the `tooldata` index currently holding the tool specified by the Q-word argument.

### 3.24.3.6 G41/G41.1/G42/G42.1

Enable cutter radius compensation (usually called *cutter comp*).

Handled by `Interp::convert_cutter_compensation_on()`.

No Canon call, cutter comp happens in the interpreter. Uses the tool table in the expected way: if a D-word tool number is supplied it looks up the pocket number of the specified tool number in the table, and if no D-word is supplied it uses pocket 0 (the spindle).

### 3.24.3.7 G40

Cancel cutter radius compensation.

Handled by `Interp::convert_cutter_compensation_off()`.

No Canon call, cutter comp happens in the interpreter. Does not use the tool table.

### 3.24.4 Internal state variables

This is not an exhaustive list! Tool information is spread through out LinuxCNC.

#### 3.24.4.1 IO

emcioStatus is of type EMC\_IO\_STAT

##### **emcioStatus.tool.pocketPrepped**

When IO gets the signal from HAL that the toolchanger prep is complete (after a Txxx command), this variable is set to the pocket of the requested tool. When IO gets the signal from HAL that the tool change itself is complete (after an M6 command), this variable gets reset to -1.

##### **emcioStatus.tool.toolInSpindle**

Tool number of the tool currently installed in the spindle. Exported on the HAL pin `iocontrol.0.tool-nr(s32)`.

##### **emcioStatus.tool.toolTable[]**

An array of CANON\_TOOL\_TABLE structures, CANON\_POCKETS\_MAX long. Loaded from the tool table file at startup and maintained there after. Index 0 is the spindle, indexes 1-(CANON\_POCKETS\_MAX-1) are the pockets in the toolchanger. This is a complete copy of the tool information, maintained separately from Interp's `settings.tool_table`.

#### 3.24.4.2 interp

settings is of type settings, defined as struct `setup_struct` in `src/emc/rs274ngc/interp_internal.h`

##### **settings.selected\_pocket**

Tooldata index of the tool most recently selected by Txxx.

##### **settings.current\_pocket**

Original tooldata index of the tool currently in the spindle. In other words: which tooldata index the tool that's currently in the spindle was loaded from.

##### **settings.tool\_table[]**

An array of tool information. The index into the array is the "pocket number" (aka "slot number"). Pocket 0 is the spindle, pockets 1 through (CANON\_POCKETS\_MAX-1) are the pockets of the toolchanger.

##### **settings.tool\_offset\_index**

Unused. FIXME: Should probably be removed.

##### **settings.toolchange\_flag**

Interp sets this to true when calling Canon's CHANGE\_TOOL() function. It is checked in `Interp::convert` to decide which tooldata index to use for G43 (with no H-word): `settings->current_pocket` if the tool change is still in progress, tooldata index 0 (the spindle) if the tool change is complete.

##### **settings.random\_toolchanger**

Set from the INI variable [EMCIO]RANDOM\_TOOLCHANGER at startup. Controls various tool table handling logic. (IO also reads this INI variable and changes its behavior based on it. For example, when saving the tool table, random toolchanger save the tool in the spindle (pocket 0), but non-random toolchanger save each tool in its "home pocket".)

##### **settings.tool\_offset**

This is an EmcPose variable.

- Used to compute position in various places.

- Sent to Motion via the EMCOT\_SET\_OFFSET message. All motion does with the offsets is export them to the HAL pins motion.0.tooloffset.[xyzabcuvw]. FIXME: export these from someplace closer to the tool table (io or interp, probably) and remove the EMCOT\_SET\_OFFSET message.

### **settings.pockets\_max**

Used interchangeably with CANON\_POCKETS\_MAX (a #defined constant, set to 1000 as of April 2020). FIXME: This settings variable is not currently useful and should probably be removed.

### **settings.tool\_table**

This is an array of CANON\_TOOL\_TABLE structures (defined in src/emc/nml\_intf/emctool.h), with CANON\_POCKETS\_MAX entries. Indexed by "pocket number", aka "slot number". Index 0 is the spindle, indexes 1 to (CANON\_POCKETS\_MAX-1) are the pockets in the tool changer. On a random toolchanger pocket numbers are meaningful. On a nonrandom toolchanger pockets are meaningless; the pocket numbers in the tool table file are ignored and tools are assigned to tool\_table slots sequentially.

### **settings.tool\_change\_at\_g30 , settings.tool\_change\_quill\_up , settings.tool\_change\_with\_spindle**

These are set from INI variables in the [EMCIO] section, and determine how tool changes are performed.

## **3.25 Reckoning of joints and axes**

### **3.25.1 In the status buffer**

The status buffer is used by Task and the UIs.

FIXME: axis\_mask and axes overspecify the number of axes

#### **status.motion.traj.axis\_mask**

A bitmask with a "1" for the axes that are present and a "0" for the axes that are not present. X is bit 0 with value  $2^0 = 1$  if set, Y is bit 1 with value  $2^1 = 2$ , Z is bit 2 with value 4, etc. For example, a machine with X and Z axes would have an axis\_mask of 0x5, an XYZ machine would have 0x7, and an XYZB machine would have an axis\_mask of 0x17.

#### **status.motion.traj.axes (removed)**

This value was removed in LinuxCNC version 2.9. Use axis\_mask instead.

#### **status.motion.traj.joints**

A count of the number of joints the machine has. A normal lathe has 2 joints; one driving the X axis and one driving the Z axis. An XYYZ gantry mill has 4 joints: one driving X, one driving one side of the Y, one driving the other side of the Y, and one driving Z. An XYZA mill also has 4 joints.

#### **status.motion.axis[EMCMOT\_MAX\_AXIS]**

An array of EMCMOT\_MAX\_AXIS axis structures. axis[n] is valid if (axis\_mask & (1 << n)) is True. If (axis\_mask & (1 << n)) is False, then axis[n] does not exist on this machine and must be ignored.

#### **status.motion.joint[EMCMOT\_MAX\_JOINTS]**

An array of EMCMOT\_MAX\_JOINTS joint structures. joint[0] through joint[joints-1] are valid, the others do not exist on this machine and must be ignored.

Things are not this way currently in the joints-axes branch, but deviations from this design are considered bugs. For an example of such a bug, see the treatment of axes in src/emc/ini/initraj.cc:loadTraj(). There are undoubtedly more, and I need your help to find them and fix them.

### 3.25.2 In Motion

The Motion controller realtime component first gets the number of joints from the `num_joints` load-time parameter. This determines how many joints worth of HAL pins are created at startup.

Motion's number of joints can be changed at runtime using the `EMCMOT_SET_NUM_JOINTS` command from Task.

The Motion controller always operates on `EMCMOT_MAX_AXIS` axes. It always creates nine sets of `axis.*.*` pins.

## Chapter 4

# NML Messages

List of NML messages.  
For details see `src/emc/nml_intf/emc.hh`.

### 4.1 OPERATOR

```
EMC_OPERATOR_ERROR_TYPE  
EMC_OPERATOR_TEXT_TYPE  
EMC_OPERATOR_DISPLAY_TYPE
```

### 4.2 JOINT

```
EMC_JOINT_SET_JOINT_TYPE  
EMC_JOINT_SET_UNITS_TYPE  
EMC_JOINT_SET_MIN_POSITION_LIMIT_TYPE  
EMC_JOINT_SET_MAX_POSITION_LIMIT_TYPE  
EMC_JOINT_SET_FERROR_TYPE  
EMC_JOINT_SET_HOMING_PARAMS_TYPE  
EMC_JOINT_SET_MIN_FERROR_TYPE  
EMC_JOINT_SET_MAX_VELOCITY_TYPE  
EMC_JOINT_INIT_TYPE  
EMC_JOINT_HALT_TYPE  
EMC_JOINT_ABORT_TYPE  
EMC_JOINT_ENABLE_TYPE  
EMC_JOINT_DISABLE_TYPE  
EMC_JOINT_HOME_TYPE  
EMC_JOINT_ACTIVATE_TYPE  
EMC_JOINT_DEACTIVATE_TYPE  
EMC_JOINT_OVERRIDE_LIMITS_TYPE  
EMC_JOINT_LOAD_COMP_TYPE  
EMC_JOINT_SET_BACKLASH_TYPE  
EMC_JOINT_UNHOME_TYPE  
EMC_JOINT_STAT_TYPE
```

### 4.3 AXIS

EMC\_AXIS\_STAT\_TYPE

## 4.4 JOG

EMC\_JOG\_CONT\_TYPE  
EMC\_JOG\_INCR\_TYPE  
EMC\_JOG\_ABS\_TYPE  
EMC\_JOG\_STOP\_TYPE

## 4.5 TRAJ

EMC\_TRAJ\_SET\_AXES\_TYPE  
EMC\_TRAJ\_SET\_UNITS\_TYPE  
EMC\_TRAJ\_SET\_CYCLE\_TIME\_TYPE  
EMC\_TRAJ\_SET\_MODE\_TYPE  
EMC\_TRAJ\_SET\_VELOCITY\_TYPE  
EMC\_TRAJ\_SET\_ACCELERATION\_TYPE  
EMC\_TRAJ\_SET\_MAX\_VELOCITY\_TYPE  
EMC\_TRAJ\_SET\_MAX\_ACCELERATION\_TYPE  
EMC\_TRAJ\_SET\_SCALE\_TYPE  
EMC\_TRAJ\_SET\_RAPID\_SCALE\_TYPE  
EMC\_TRAJ\_SET\_MOTION\_ID\_TYPE  
EMC\_TRAJ\_INIT\_TYPE  
EMC\_TRAJ\_HALT\_TYPE  
EMC\_TRAJ\_ENABLE\_TYPE  
EMC\_TRAJ\_DISABLE\_TYPE  
EMC\_TRAJ\_ABORT\_TYPE  
EMC\_TRAJ\_PAUSE\_TYPE  
EMC\_TRAJ\_STEP\_TYPE  
EMC\_TRAJ\_RESUME\_TYPE  
EMC\_TRAJ\_DELAY\_TYPE  
EMC\_TRAJ\_LINEAR\_MOVE\_TYPE  
EMC\_TRAJ\_CIRCULAR\_MOVE\_TYPE  
EMC\_TRAJ\_SET\_TERM\_COND\_TYPE  
EMC\_TRAJ\_SET\_OFFSET\_TYPE  
EMC\_TRAJ\_SET\_G5X\_TYPE  
EMC\_TRAJ\_SET\_HOME\_TYPE  
EMC\_TRAJ\_SET\_ROTATION\_TYPE  
EMC\_TRAJ\_SET\_G92\_TYPE  
EMC\_TRAJ\_CLEAR\_PROBE\_TRIPPED\_FLAG\_TYPE  
EMC\_TRAJ\_PROBE\_TYPE  
EMC\_TRAJ\_SET\_TÉLEOP\_ENABLE\_TYPE  
EMC\_TRAJ\_SET\_SPINDLESYNC\_TYPE  
EMC\_TRAJ\_SET\_SPINDLE\_SCALE\_TYPE  
EMC\_TRAJ\_SET\_F0\_ENABLE\_TYPE  
EMC\_TRAJ\_SET\_S0\_ENABLE\_TYPE  
EMC\_TRAJ\_SET\_FH\_ENABLE\_TYPE  
EMC\_TRAJ\_RIGID\_TAP\_TYPE  
EMC\_TRAJ\_STAT\_TYPE

## 4.6 MOTION

```
EMC_MOTION_INIT_TYPE
EMC_MOTION_HALT_TYPE
EMC_MOTION_ABORT_TYPE
EMC_MOTION_SET_AOUT_TYPE
EMC_MOTION_SET_DOUT_TYPE
EMC_MOTION_ADAPTIVE_TYPE
EMC_MOTION_STAT_TYPE
```

## 4.7 TASK

```
EMC_TASK_INIT_TYPE
EMC_TASK_HALT_TYPE
EMC_TASK_ABORT_TYPE
EMC_TASK_SET_MODE_TYPE
EMC_TASK_SET_STATE_TYPE
EMC_TASK_PLAN_OPEN_TYPE
EMC_TASK_PLAN_RUN_TYPE
EMC_TASK_PLAN_READ_TYPE
EMC_TASK_PLAN_EXECUTE_TYPE
EMC_TASK_PLAN_PAUSE_TYPE
EMC_TASK_PLAN_STEP_TYPE
EMC_TASK_PLAN_RESUME_TYPE
EMC_TASK_PLAN_END_TYPE
EMC_TASK_PLAN_CLOSE_TYPE
EMC_TASK_PLAN_INIT_TYPE
EMC_TASK_PLAN_SYNCH_TYPE
EMC_TASK_PLAN_SET_OPTIONAL_STOP_TYPE
EMC_TASK_PLAN_SET_BLOCK_DELETE_TYPE
EMC_TASK_PLAN_OPTIONAL_STOP_TYPE
EMC_TASK_STAT_TYPE
```

## 4.8 TOOL

```
EMC_TOOL_INIT_TYPE
EMC_TOOL_HALT_TYPE
EMC_TOOL_ABORT_TYPE
EMC_TOOL_PREPARE_TYPE
EMC_TOOL_LOAD_TYPE
EMC_TOOL_UNLOAD_TYPE
EMC_TOOL_LOAD_TOOL_TABLE_TYPE
EMC_TOOL_SET_OFFSET_TYPE
EMC_TOOL_SET_NUMBER_TYPE
EMC_TOOL_START_CHANGE_TYPE
EMC_TOOL_STAT_TYPE
```

## 4.9 AUX

```
EMC_AUX_ESTOP_ON_TYPE
EMC_AUX_ESTOP_OFF_TYPE
EMC_AUX_ESTOP_RESET_TYPE
EMC_AUX_INPUT_WAIT_TYPE
EMC_AUX_STAT_TYPE
```

## 4.10 SPINDLE

```
EMC_SPINDLE_ON_TYPE
EMC_SPINDLE_OFF_TYPE
EMC_SPINDLE_INCREASE_TYPE
EMC_SPINDLE_DECREASE_TYPE
EMC_SPINDLE_CONSTANT_TYPE
EMC_SPINDLE_BRAKE_RELEASE_TYPE
EMC_SPINDLE_BRAKE_ENGAGE_TYPE
EMC_SPINDLE_SPEED_TYPE
EMC_SPINDLE_ORIENT_TYPE
EMC_SPINDLE_WAIT_ORIENT_COMPLETE_TYPE
EMC_SPINDLE_STAT_TYPE
```

## 4.11 COOLANT

```
EMC_COOLANT_MIST_ON_TYPE
EMC_COOLANT_MIST_OFF_TYPE
EMC_COOLANT_FLOOD_ON_TYPE
EMC_COOLANT_FLOOD_OFF_TYPE
EMC_COOLANT_STAT_TYPE
```

## 4.12 LUBE

```
EMC_LUBE_ON_TYPE
EMC_LUBE_OFF_TYPE
EMC_LUBE_STAT_TYPE
```

## 4.13 IO (Input/Output)

```
EMC_IO_INIT_TYPE
EMC_IO_HALT_TYPE
EMC_IO_ABORT_TYPE
EMC_IO_SET_CYCLE_TIME_TYPE
EMC_IO_STAT_TYPE
EMC_IO_PLUGIN_CALL_TYPE
```

## 4.14 Others

```
EMC_NULL_TYPE
EMC_SET_DEBUG_TYPE
EMC_SYSTEM_CMD_TYPE
EMC_INIT_TYPE
EMC_HALT_TYPE
EMC_ABORT_TYPE
EMC_STAT_TYPE
EMC_EXEC_PLUGIN_CALL_TYPE
```



# Chapter 5

## Coding Style

This chapter describes the source code style preferred by the LinuxCNC team.

### 5.1 Do no harm

When making small edits to code in a style different than the one described below, observe the local coding style. Rapid changes from one coding style to another decrease code readability.

Never check in code after running "indent" on it. The whitespace changes introduced by indent make it more difficult to follow the revision history of the file.

Do not use an editor that makes unneeded changes to whitespace (e.g., which replaces 8 spaces with a tabstop on a line not otherwise modified, or word-wraps lines not otherwise modified).

### 5.2 Tab Stops

A tab stop always corresponds to 8 spaces. Do not write code that displays correctly only with a differing tab stop setting.

### 5.3 Indentation

Use 4 spaces per level of indentation. Combining 8 spaces into one tab is acceptable but not required.

### 5.4 Placing Braces

Put the opening brace last on the line, and put the closing brace first:

```
if (x) {  
    // do something appropriate  
}
```

The closing brace is on a line of its own, except in the cases where it is followed by a continuation of the same statement, i.e. a *while* in a do-statement or an *else* in an if-statement, like this:

---

```
do {  
    // something important  
} while (x > 0);
```

and

```
if (x == y) {  
    // do one thing  
} else if (x < y) {  
    // do another thing  
} else {  
    // do a third thing  
}
```

This brace-placement also minimizes the number of empty (or almost empty) lines, which allows a greater amount of code or comments to be visible at once in a terminal of a fixed size.

## 5.5 Naming

C is a Spartan language, and so should your naming be. Unlike Modula-2 and Pascal programmers, C programmers do not use cute names like `ThisVariableIsATemporaryCounter`. A C programmer would call that variable `tmp`, which is much easier to write, and not the least more difficult to understand.

However, descriptive names for global variables are a must. To call a global function `foo` is a shooting offense.

GLOBAL variables (to be used only if you **really** need them) need to have descriptive names, as do global functions. If you have a function that counts the number of active users, you should call that `count_active_users()` or similar, you should **not** call it `cntusr()`.

Encoding the type of a function into the name (so-called Hungarian notation) is brain damaged - the compiler knows the types anyway and can check those, and it only confuses the programmer. No wonder Microsoft makes buggy programs.

LOCAL variable names should be short, and to the point. If you have some random integer loop counter, it should probably be called `i`. Calling it `loop_counter` is non-productive, if there is no chance of it being misunderstood. Similarly, `tmp` can be just about any type of variable that is used to hold a temporary value.

If you are afraid to mix up your local variable names, you have another problem, which is called the function-growth-hormone-imbalance syndrome. See next chapter.

## 5.6 Functions

Functions should be short and sweet, and do just one thing. They should fit on one or two screenfuls of text (the ISO/ANSI screen size is 80x24, as we all know), and do one thing and do that well.

The maximum length of a function is inversely proportional to the complexity and indentation level of that function. So, if you have a conceptually simple function that is just one long (but simple) case-statement, where you have to do lots of small things for a lot of different cases, it's OK to have a longer function.

However, if you have a complex function, and you suspect that a less-than-gifted first-year high-school student might not even understand what the function is all about, you should adhere to the maximum limits all the more closely. Use helper functions with descriptive names (you can ask the compiler to in-line them if you think it's performance-critical, and it will probably do a better job of it that you would have done).

Another measure of the function is the number of local variables. They shouldn't exceed 5-10, or you're doing something wrong. Re-think the function, and split it into smaller pieces. A human brain can generally easily keep track of about 7 different things, anything more and it gets confused. You know you're brilliant, but maybe you'd like to understand what you did 2 weeks from now.

## 5.7 Commenting

Comments are good, but there is also a danger of over-commenting. NEVER try to explain HOW your code works in a comment: it's much better to write the code so that the **working** is obvious, and it's a waste of time to explain badly written code.

Generally, you want your comments to tell WHAT your code does, not HOW. A boxed comment describing the function, return value, and who calls it placed above the body is good. Also, try to avoid putting comments inside a function body: if the function is so complex that you need to separately comment parts of it, you should probably re-read the Functions section again. You can make small comments to note or warn about something particularly clever (or ugly), but try to avoid excess. Instead, put the comments at the head of the function, telling people what it does, and possibly WHY it does it.

If comments along the lines of `/* Fix me */` are used, please, please, say why something needs fixing. When a change has been made to the affected portion of code, either remove the comment, or amend it to indicate a change has been made and needs testing.

## 5.8 Shell Scripts & Makefiles

Not everyone has the same tools and packages installed. Some people use vi, others emacs - A few even avoid having either package installed, preferring a lightweight text editor such as nano or the one built in to Midnight Commander.

gawk versus mawk - Again, not everyone will have gawk installed, mawk is nearly a tenth of the size and yet conforms to the POSIX AWK standard. If some obscure gawk specific command is needed that mawk does not provide, then the script will break for some users. The same would apply to mawk. In short, use the generic awk invocation in preference to gawk or mawk.

## 5.9 C++ Conventions

C++ coding styles are always likely to end up in heated debates (a bit like the emacs versus vi arguments). One thing is certain however, a common style used by everyone working on a project leads to uniform and readable code.

Naming conventions: Constants either from `#defines` or enumerations should be in upper case throughout. Rationale: Makes it easier to spot compile time constants in the source code, e.g., `EMC_MESSAGE_TYP`

Classes and Namespaces should capitalize the first letter of each word and avoid underscores. Rationale: Identifies classes, constructors and destructors, e.g., `GtkWidget`.

Methods (or function names) should follow the C recommendations above and should not include the class name. Rationale: Maintains a common style across C and C++ sources, e.g., `get_foo_bar()`.

However, boolean methods are easier to read if they avoid underscores and use an *is* prefix (not to be confused with methods that manipulate a boolean). Rationale: Identifies the return value as TRUE or FALSE and nothing else, e.g., `isOpen`, `isHomed`.

Do NOT use *Not* in a boolean name, it leads only leads to confusion when doing logical tests, e.g., `isNotOnLimit` or `is_not_on_limit` are BAD.

---

Variable names should avoid the use of upper case and underscores except for local or private names. The use of global variables should be avoided as much as possible. Rationale: Clarifies which are variables and which are methods. Public: e.g., axislimit Private: e.g., maxvelocity\_ .

### 5.9.1 Specific method naming conventions

The terms get and set should be used where an attribute is accessed directly. Rationale: Indicates the purpose of the function or method, e.g., get\_foo set\_bar.

For methods involving boolean attributes, set & reset is preferred. Rationale: As above. e.g. set\_amp\_enable reset\_amp\_fault

Math intensive methods should use compute as a prefix. Rationale: Shows that it is computationally intensive and will hog the CPU. e.g. compute\_PID

Abbreviations in names should be avoided where possible - The exception is for local variable names. Rationale: Clarity of code. e.g. pointer is preferred over ptr compute is preferred over cmp compare is again preferred over cmp.

Enumerates and other constants can be prefixed by a common type name, e.g., enum COLOR { COLOR\_RED, COLOR\_BLUE }; .

Excessive use of macros and defines should be avoided - Using simple methods or functions is preferred. Rationale: Improves the debugging process.

Include Statements Header files must be included at the top of a source file and not scattered throughout the body. They should be sorted and grouped by their hierarchical position within the system with the low level files included first. Include file paths should NEVER be absolute - Use the compiler -I flag instead to extend the search path. Rationale: Headers may not be in the same place on all systems.

Pointers and references should have their reference symbol next to the variable name rather than the type name. Rationale: Reduces confusion, e.g., float \*x or int &i.

Implicit tests for zero should not be used except for boolean variables, e.g., if (spindle\_speed != 0) NOT if (spindle\_speed).

Only loop control statements must be included in a for() construct, e.g., sum = 0; for (i=0; i<10; i++) { sum += value[i]; }

NOT: for (i=0, sum=0; i<10; i++) sum += value[i];.

Likewise, executable statements in conditionals must be avoided, e.g., if (fd = open(file\_name)) is bad.

Complex conditional statements should be avoided - Introduce temporary boolean variables instead.

Parentheses should be used in plenty in mathematical expressions - Do not rely on operator precedence when an extra parentheses would clarify things.

File names: C++ sources and headers use .cc and .hh extension. The use of .c and .h are reserved for plain C. Headers are for class, method, and structure declarations, not code (unless the functions are declared inline).

## 5.10 Python coding standards

Use the [PEP 8](#) style for Python code.

## 5.11 Comp coding standards

In the declaration portion of a .comp file, begin each declaration at the first column. Insert extra blank lines when they help group related items.

In the code portion of a .comp file, follow normal C coding style.

## Chapter 6

# Building LinuxCNC

### 6.1

This document describes how to build the LinuxCNC software from source. This is primarily useful if you are a developer who is modifying LinuxCNC. It can also be useful if you're a user who is testing developer branches, though then you also have the option of just installing Debian packages from the buildbot (<http://buildbot.linuxcnc.org>) or as a regular package from your Linux distribution (<https://tracker.debian.org/pkg/linuxcnc>). Admittedly, this section also exists since LinuxCNC is a community effort, and you are encouraged to contribute to the development of LinuxCNC. Generally, you want to compile LinuxCNC yourself for immediate functional access to a new development of LinuxCNC or a new development you perhaps want to contribute to LinuxCNC or help other completing it.

You may for instance be porting LinuxCNC to some new Linux distribution or, and this common, a developer reacts to you reporting a problem whose fix you want to test. Any such change will see no buildbot to help, or that help is delayed, pending someone else's review that you do not want to wait for or you are the only other individual with a particular hardware to test the code.

Besides the programs that control your machine that are built from the source tree, you can also build the same PDFs and/or HTML files that you are likely to have encountered online on <https://linuxcnc.org/documents/>.

If you want to contribute to LinuxCNC but are uncertain about where to start, please seriously consider to contribute to the documentation. Everyone always finds something to improve - and if you only leave a "FIXME: with a comment" in the text as a reference for yourself and others to revisit a section later. Also, translations to languages other than English are very likely to benefit from your scrutiny at <https://hosted.weblate.org/projects/linuxcnc/>.

### 6.2 Downloading source tree

The LinuxCNC project git repository is at <https://github.com/LinuxCNC/linuxcnc>. GitHub is a popular git hosting service and code sharing website.

To retrieve the source tree you have two options:

#### Download tarball

On the LinuxCNC project page in GitHub find a reference to the "releases" or "tags", click that hyperlink to the archive page and download the latest .tar file. You will find that file compressed as a .tar.xz or .tar.gz file. This file, commonly referred to as a "tarball" is an archive very analogous to a .zip. Your Linux desktop will know how to treat that file when double-clicking on it.

### Prepare a local copy of the LinuxCNC repository

You would first install the tool "git" on your machine if it is not available already (sudo apt install git). Then prepare a local instance of the source tree as follows: .

```
$ git clone https://github.com/LinuxCNC/linuxcnc.git linuxcnc-source-dir
```

. The first argument to the git command gives it away: This is called a "clone" of the LinuxCNC repository. The advantage is that this local clone supports the communication about changes you may decide to perform on the source tree.

GitHub is an infrastructure on its own and explained in depth elsewhere. Just to get you motivated if you do not know it already, offers to perform a clone for you and have that instance made publicly available. GitHub refers to such an additional instance of another repository as a "fork". You can easily (and at no cost) create a fork of the LinuxCNC git repository at GitHub, and use that to track and publish your changes. After creating your own GitHub fork of LinuxCNC, clone it to your development machine and proceed with your hacking as usual.

We of the LinuxCNC project hope that you will share your changes with us, so that the community can benefit from your work. GitHub makes this sharing very easy: After you polish your changes and push them to your github fork, send us a Pull Request.

### 6.2.1 Quick Start

For the impatient, try this:

```
$ git clone https://github.com/LinuxCNC/linuxcnc.git linuxcnc-source-dir
$ cd linuxcnc-source-dir/src
$ ./autogen.sh
$ ./configure --with-realtime=uspace
$ make
```

That will probably fail! That doesn't make you a bad person, it just means you should read this whole document to find out how to fix your problems. Especially the section on [Satisfying Build Dependencies](#).

If you are running on a realtime-capable system (such as an install from the LinuxCNC Live/Install Image, see the [Realtime](#) section below), one extra build step is needed at this time:

```
$ sudo make setuid
```

After you have successfully built LinuxCNC it is time to run the tests:

```
$ source ../scripts/rip-environment
$ runtests
```

This might fail, too! Read this whole document, especially the section on [Setting up the test environment](#).

## 6.3 Supported Platforms

The LinuxCNC project targets modern Debian-based distributions, including Debian, Ubuntu, and Mint. We continuously test on the platforms listed at <http://buildbot.linuxcnc.org>.

LinuxCNC builds on most other Linux distributions, though dependency management will be more manual and less automatic. Patches to improve portability to new platforms are always welcome.

### 6.3.1 Realtime

LinuxCNC is a machine tool controller, and it requires a realtime platform to do this job. This version of LinuxCNC supports the following platforms. The first three listed are realtime operating systems:

#### RTAI

From <https://www.rtai.org>. A Linux kernel with the RTAI patch is available from the Debian archive at <https://linuxcnc.org>. See [Getting LinuxCNC](#) for installation instructions.

#### Xenomai

From <https://xenomai.org>. You will have to compile or obtain a Xenomai kernel yourself.

#### Preempt-RT

From <https://rt.wiki.kernel.org>. A Linux kernel with the Preempt-RT patch is occasionally available from the Debian archive at <https://www.debian.org>, and from the wayback machine at <https://snaps>

#### Non-realtime

LinuxCNC can also be built and run on non-realtime platforms, such as a regular install of Debian or Ubuntu without any special realtime kernel.

In this mode LinuxCNC is not useful for controlling machine tools, but it is useful for simulating the execution of G-code and for testing the non-realtime parts of the system (such as the user interfaces, and some kinds of components and device drivers).

To make use of the realtime capabilities of LinuxCNC, certain parts of LinuxCNC need to run with root privileges. To enable root for these parts, run this extra command after the make that builds LinuxCNC:

```
$ sudo make setuid
```

## 6.4 Build modes

There are two ways to build LinuxCNC: The developer-friendly "run in place" mode and the user-friendly Debian packaging mode.

### 6.4.1 Building for Run In Place

In a Run-In-Place build, the LinuxCNC programs are compiled from source and then run directly from within the build directory. Nothing is installed outside the build directory. This is quick and easy, and suitable for rapid iteration of changes. The LinuxCNC test suite runs only in a Run-In-Place build. Most LinuxCNC developers primarily build using this mode.

Building for Run-In-Place follows the steps in the [Quick Start](#) section at the top of this document, possibly with different arguments to `src/configure` and `make`.

#### 6.4.1.1 src/configure arguments

The `src/configure` script configures how the source code will be compiled. It takes many optional arguments. List all arguments to `src/configure` by running this:

```
$ cd linuxcnc-source-dir/src
$ ./configure --help
```

The most commonly used arguments are:

**--with-realtime=uspace**

Build for any realtime platform, or for non-realtime. The resulting LinuxCNC executables will run on both a Linux kernel with Preempt-RT patches (providing realtime machine control) and on a vanilla (un-patched) Linux kernel (providing G-code simulation but no realtime machine control).

If development files are installed for Xenomai (typically from package `libxenomai-dev`) or RTAI (typically from a package with a name starting "`rtai-modules`"), support for these real-time kernels will also be enabled.

**--with-realtime=/usr/realtime-\$VERSION**

Build for the RTAI realtime platform using the older "kernel realtime" model. This requires that you have an RTAI kernel and the RTAI modules installed in `/usr/realtime-$VERSION`. The resulting LinuxCNC executables will only run on the specified RTAI kernel. As of LinuxCNC 2.7, this produces the best realtime performance.

**--enable-build-documentation**

Build the documentation, in addition to the executables. This option adds significantly to the time required for compilation, as building the docs is quite time consuming. If you are not actively working on the documentation you may want to omit this argument.

**--disable-build-documentation-translation**

Disable building the translated documentation for all available languages. The building of the translated documentation takes a huge amount of time, so it is recommend to skip that if not really needed.

### 6.4.1.2 make arguments

The make command takes two useful optional arguments.

**Parallel compilation**

make takes an optional argument `-j N` (where `N` is a number). This enables parallel compilation with `N` simultaneous processes, which can significantly speed up your build.

A useful value for `N` is the number of CPUs in your build system.

You can discover the number of CPUs by running `nproc`.

**Building just a specific target**

If you want to build just a specific part of LinuxCNC, you can name the thing you want to build on the make command line. For example, if you are working on a component named `froboz`, you can build its executable by running:

```
$ cd linuxcnc-source-dir/src
$ make ../bin/froboz
```

## 6.4.2 Building Debian Packages

When building Debian packages, the LinuxCNC programs are compiled from source and then stored in a Debian package, complete with dependency information. This process by default also includes the building of the documentation, which takes its time because of all the I/O for many languages, but that can be skipped. LinuxCNC is then installed as part of those packages on the same machines or on whatever machine of the same architecture that the `.deb` files are copied to. LinuxCNC cannot be run until the Debian packages are installed on a target machine and then the executables are available in `/usr/bin` and `/usr/lib` just like other regular software of the system.



This build mode is primarily useful when packaging the software for delivery to end users, and when building the software for a machine that does not have the build environment installed, or that does not have internet access.

To build packages is primarily useful when packaging the software for delivery to end users. Developers among themselves exchange only the source code, likely supported by the LinuxCNC GitHub repository referenced below. Also, when building the software for a machine that doesn't have the build environment installed, or that doesn't have internet access, one happily accepts a prebuilt package.

Building Debian packages is performed with the `dpkg-buildpackage` tool that is provided by the `dpkg-dev` package. Its execution comes with a series of prerequisites that are detailed below: \* general build infrastructure shall be installed, i.e. compilers, etc. \* build-time dependencies are to be installed, i.e. header files for external code libraries used, as described in the section [Satisfying Build Dependencies](#). \* file in debian folder need to be complete that describe the package

Build tools have been gathered as a virtual package named `build-essential`. To install it, run:

```
$ sudo apt-get install build-essential
```

Once those prerequisites are met, building the Debian packages consists of two steps.

The first step is generating the Debian package scripts and meta-data from the git repo by running this:

```
$ cd linuxcnc-dev
$ ./debian/configure
```

---

□□

The `debian/configure` script is different from the `src/configure` script!

The `debian/configure` accepts arguments depending on the platform you are building on/for, see the [debian/configure arguments](#) section. It defaults to LinuxCNC running in user space ("uspace"), expecting the `preempt_rt` kernel to minimize latencies.

---

Once the Debian package scripts and meta-data are configured, build the package by running `dpkg-buildpackage`

```
$ dpkg-buildpackage -b -uc
```

---

□□

`dpkg-buildpackage` needs to run from the root of the source tree, which you may have named `linuxcnc-source-dir`, **not** from within `linuxcnc-source-dir/debian`.

`dpkg-buildpackage` takes an optional argument `-j`N` (where `N` is a number). This enables to run multiple jobs simultaneously.

---

#### 6.4.2.1 LinuxCNC's `debian/configure` arguments

The LinuxCNC source tree has a `debian` directory with all the info about how the Debian package shall be built, but some key files within are only distributed as templates. The `debian/configure` script readies those build instructions for the regular Debian packaging utilities and must thus be run prior to `dpkg-checkbuilddeps` or `dpkg-buildpackage`.

The `debian/configure` script takes a single argument which specifies the underlying realtime or non-realtime platform to build for. The regular values for this argument are:

---

**no-docs**

Skip building documentation.

**uspace**

Configure the Debian package for Preempt-RT realtime or for non-realtime (these two are compatible).

**noauto , rtai , xenomai**

Normally, the lists of RTOSes for uspace realtime to support is detected automatically. However, if you wish, you may specify one or more of these after uspace to enable support for these RTOSes. Or, to disable autodetection, specify noauto.

If you want just the traditional RTAI "kernel module" realtime, use `-r` or `$KERNEL_VERSION` instead.

**rtai=<package name>**

If the development package for RTAI, `lxrt`, does not start with "rtai-modules", or if the first such package listed by `apt-cache search` is not the desired one, then explicitly specify the package name.

**-r**

Configure the Debian package for the currently running RTAI kernel. You must be running an RTAI kernel on your build machine for this to work!

**\$KERNEL\_VERSION**

Configure the Debian package for the specified RTAI kernel version (for example "3.4.9-rtai-686-pae"). The matching kernel headers Debian package must be installed on your build machine, e.g. "linux-headers-3.4.9-rtai-686-pae". Note that you can *build* LinuxCNC in this configuration, but if you are not running the matching RTAI kernel you will not be able to *run* LinuxCNC, including the test suite.

### 6.4.2.2 Satisfying Build Dependencies

On Debian-based platforms we provide packaging meta-data that knows what external software packages need to be installed in order to build LinuxCNC. These are referred to as the *build dependencies* of LinuxCNC, i.e. those packages that need to be available such that \* the build succeeds and \* the build can be built reproducibly.

You can use this meta-data to easily list the required packages missing from your build system. First, go to the source tree of LinuxCNC and initiate its default self-configuration, if not already performed:

```
$ cd linuxcnc-dev
$ ./debian/configure
```

This will prepare the file `debian/control` that contains lists of Debian packages to create with the runtime dependencies for those packages and for our cause also the build-dependencies for those to-be-created packages.

The most straightforward way to get all build-dependencies installed is to just execute (from the same directory):

```
sudo apt-get build-dep .
```

which will install all the dependencies required, not yet installed, but available. The `.` is part of the command line, i.e. an instruction to retrieve the dependencies for the source tree at hand, not for dependencies of another package. This completes the installation of build-dependencies.

The remainder of this section describes a semi-manual approach. The list of dependencies in `debian/control` is long and it is tedious to compare the current state of packages already installed with it. Debian systems provide a program called `dpkg-checkbuilddeps` that parses the package meta-data

and compares the packages listed as build dependencies against the list of installed packages, and tells you what's missing.

First, install the `dpkg-checkbuilddeps` program by running:

```
$ sudo apt-get install dpkg-dev
```

This generates the file `debian/control` in a user-readable yml-format which lists the build-dependencies close to the top. You can use this meta-data to easily list the required packages missing from your build system. You may decide to manually inspecting those files if you have a good understanding what is already installed.

Alternatively, Debian systems provide a program called `dpkg-checkbuilddeps` that parses the package meta-data and compares the packages listed as build dependencies against the list of installed packages, and tells you what's missing. Also, `dpkg-buildpackage` would inform you about what is missing, and it should be fine. However, it reports missing build-deps only after patches in the directory `debian/patches` have been automatically applied (if any). If you are new to Linux and git version management, a clean start may be preferable to avoid complications.

The `dpkg-checkbuilddeps` (also from the `dpkg-dev` package that is installed as part of the build-essential dependencies) program can be asked to do its job (note that it needs to run from the `linuxcnc-source-dir` directory, **not** from `linuxcnc-source-dir/debian`):

```
$ dpkg-checkbuilddeps
```

It will emit a list of packages that are required to build LinuxCNC on your system but are not installed, yet. You can now install missing build-dependencies

#### **manually**

Install them all with `sudo apt-get install`, followed by the package names. You can rerun `dpkg-checkbuilddeps` any time you want, to list any missing packages, which has no effect on the source tree.

#### **automated**

Run `sudo apt build-dep . .`

If in doubt about what a particular package of a build-dep may be providing, check out the package's description with ```apt-cache show`` packagename`.

### **6.4.2.3 Options for dpkg-buildpackage**

For a typical Debian package to build, you would run `dpkg-buildpackage` without any arguments. As introduced above, the command has two extra options passed to it. Like for all good Linux tools, the man page has all the details with `man dpkg-buildpackage`.

#### **-uc**

Do not digitally sign the resulting binaries. You would want to sign your packages with a GPG key of yours only if you would wanted to distribute them to others. Having that option not set and then failing to sign the package would not affect the `.deb` file.

#### **-b**

Only compiles the architecture-dependent packages (like the `linuxcnc` binaries and GUIs). This is very helpful to avoid compiling what is hardware-independent. For LinuxCNC this is the documentation, which is available online anyway.

If you happen to run into difficulties while compiling, check the LinuxCNC forum online.

Currently emerging is the support for the `DEB_BUILD_OPTIONS` environment variable. Set it to

**nodocs**

to skip building the documentation, preferably instead use the `-B` flag to `dpkg-buildpackage`.

**nocheck**

to skip self-tests of the LinuxCNC build process. This saves some time and reduces the demand for a few software packages that may not be available for your system, i.e. the `xvfb` in particular. You should not set this option to gain some extra confidence in your build to perform as expected unless you are running into mere technical difficulties with the test-specific software dependencies.

An environment variable can be set together with the execution of the command, e.g.

```
DEB_BUILD_OPTIONS=nocheck dpkg-buildpackage -uc -B
```

would combine all the options introduced in this section.

#### 6.4.2.4 Installing self-built Debian packages

A Debian package can be recognised by its `.deb` extension. The tool installing it, `dpkg` is part of every Debian installation. The `.deb` files created by `dpkg-buildpackage` are found in the directory above the `linuxcnc-source-dir`, i.e. in `...` To see what files are provided in a package, run

```
dpkg -c ../linuxcnc-uspace*.deb
```

The version of LinuxCNC will be part of the file name, which is meant to be matched by the asterisk. There may be too many files listed to fit on your screen. If you cannot scroll up in your terminal then add `| more` to that command to have its output passed through a so-called "pager". Quit with "q".

To install the packages, run

```
sudo dpkg -i ../linuxcnc*.deb
```

## 6.5 Setting up the environment

This section describes the special steps needed to set up a machine to run the LinuxCNC programs, including the tests.

### 6.5.1 Increase the locked memory limit

LinuxCNC tries to improve its realtime latency by locking the memory it uses into RAM. It does this in order to prevent the operating system from swapping LinuxCNC out to disk, which would have bad effects on latency. Normally, locking memory into RAM is frowned upon, and the operating system places a strict limit on how much memory a user is allowed to have locked.

When using the Preempt-RT realtime platform LinuxCNC runs with enough privilege to raise its memory lock limit itself. When using the RTAI realtime platform it does not have enough privilege, and the user must raise the memory lock limit.

If LinuxCNC displays the following message on startup, the problem is your system's configured limit on locked memory:

```
RTAPI: ERROR: failed to map shmem
RTAPI: Locked memory limit is 32KiB, recommended at least 20480KiB.
```

To fix this problem, add a file named `/etc/security/limits.d/linuxcnc.conf` (as root) with your favorite text editor (e.g., `sudo gedit /etc/security/limits.d/linuxcnc.conf`). The file should contain the following line:

```
* - memlock 20480
```

Log out and log back in to make the changes take effect. Verify that the memory lock limit is raised using the following command:

```
$ ulimit -l
```

## 6.6 Building on Gentoo

Building on Gentoo is possible, but not supported. Be sure you are running a desktop profile. This project uses the Tk Widget Set, asciidoc, and has some other dependencies. They should be installed as root:

```
~ # euse -E tk imagequant
~ # emerge -uDNa world
~ # emerge -a dev-libs/libmodbus dev-lang/tk dev-tcltk/bwidget dev-tcltk/tclx
~ # emerge -a dev-python/pygobject dev-python/pyopengl dev-python/numpy
~ # emerge -a app-text/asciidoc app-shells/bash-completion
```

You can switch back to being a normal user for most of the rest of the install. As that user, create a virtual environment for pip, then install the pip packages:

```
~/src $ python -m venv --system-site-packages ~/src/venv
~/src $ . ~/src/venv/bin/activate
(venv) ~/src $ pip install yapps2
(venv) ~/src $
```

Then you can continue as normally:

```
(venv) ~/src $ git clone https://github.com/LinuxCNC/linuxcnc.git
(venv) ~/src $ cd linuxcnc
(venv) ~/src $ cd src
(venv) ~/src $ ./autogen.sh
(venv) ~/src $ ./configure --enable-non-distributable=yes
(venv) ~/src $ make
```

There is no need to run “make suid”, just make sure your user is in the “dialout” group. To start linuxcnc, you must be in the Python Virtual Environment, and set up the linuxcnc environment:

```
~ $ . ~/src/venv/bin/activate
(venv) ~ $ . ~/src/linuxcnc/scripts/rip-environment
(venv) ~ $ ~/src/linuxcnc $ scripts/linuxcnc
```

## 6.7 Options for checking out the git repo

The [Quick Start](#) instructions at the top of this document clone our git repo at <https://github.com/LinuxCNC/linuxcnc.git>. This is the quickest, easiest way to get started. However, there are other options to consider.

### 6.7.1 Fork us on GitHub

The LinuxCNC project git repo is at <https://github.com/LinuxCNC/linuxcnc>. GitHub is a popular git hosting service and code sharing website. You can easily (and at no costs) create a fork (a second instance holding a copy that you control) of the LinuxCNC git repository at GitHub. You can then use that fork of yours to track and publish your changes, receive comments to your changes and accept patches from the community. .

After creating your own GitHub fork of LinuxCNC, clone it to your development machine and proceed with your hacking as usual.

We of the LinuxCNC project hope that you will share your changes with us, so that the community can benefit from your work. GitHub makes this sharing very easy: after you polish your changes and push them to your GitHub fork, send us a Pull Request.

## Chapter 7

# Adding Configuration Selection Items

Example Configurations can be added to the Configuration Selector by two methods:

- Auxiliary applications — Applications installed independently with a deb package can place configuration subdirectories in a specified system directory. The directory name is specified using the shell `linuxcnc_var` script:

```
$ linuxcnc_var LINUXCNC_AUX_EXAMPLES  
/usr/share/linuxcnc/aux_examples
```

- Runtime settings — the configuration selector can also offer configuration subdirectories specified at runtime using an exported environmental variable (`LINUXCNC_AUX_CONFIGS`). This variable should be a path list of one or more configuration directories separated by a (:). Typically, this variable would be set in a shell starting `linuxcnc` or in a user's `~/.profile` startup script. Example:

```
export LINUXCNC_AUX_CONFIGS=~/.myconfigs:/opt/otherconfigs
```

---

## Chapter 8

# Contributing to LinuxCNC

### 8.1 □□

This document contains information for developers about LinuxCNC infrastructure, and describes the best practices for contributing code and documentation updates to the LinuxCNC project.

Throughout this document, "source" means both the source code to the programs and libraries, and the source text for the documentation.

### 8.2 Communication among LinuxCNC developers

The two main ways that project developers communicate with each other are:

- Via IRC, at [#linuxcnc-devel](#) on [Libera.chat](#).
- Via email, on the [developers' mailing list](#)

### 8.3 The LinuxCNC Source Forge project

We use Source Forge for [mailing lists](#).

### 8.4 The Git Revision Control System

All of the LinuxCNC source is maintained in the [Git revision control system](#).

#### 8.4.1 LinuxCNC official Git repo

The official LinuxCNC git repo is at <https://github.com/linuxcnc/linuxcnc/>

Anyone can get a read-only copy of the LinuxCNC source tree via git:

```
git clone https://github.com/linuxcnc/linuxcnc linuxcnc-dev
```



If you are a developer with push access, then follow github's instructions for setting up a repository that you can push from.

Note that the clone command put the local LinuxCNC repo in a directory called `linuxcnc-dev`, instead of the default `linuxcnc`. This is because the LinuxCNC software by default expects configs and G-code programs in a directory called `$HOME/linuxcnc`, and having the git repo there too is confusing.

Issues and pull requests (abbreviated PRs) are welcome on GitHub: <https://github.com/LinuxCNC/linuxcnc/issues> <https://github.com/LinuxCNC/linuxcnc/pulls>

## 8.4.2 Use of Git in the LinuxCNC project

We use the "merging upwards" and "topic branches" git workflows described here:

<https://www.kernel.org/pub/software/scm/git/docs/gitworkflows.html>

We have a development branch called `master`, and one or more stable branches with names like `2.6` and `2.7` indicating the version number of the releases we make from it.

Bugfixes go in the oldest applicable stable branch, and that branch gets merged into the next newer stable branch, and so on up to `master`. The committer of the bugfix may do the merges themselves, or they may leave the merges for someone else.

New features generally go in the `master` branch, but some kinds of features (specifically well isolated device drivers and documentation) may (at the discretion of the stable branch release managers) go into a stable branch and get merged up just like bugfixes do.

## 8.4.3 git tutorials

There are many excellent, free git tutorials on the internet.

The first place to look is probably the "gittutorial" manpage. This manpage is accessible by running "man gittutorial" in a terminal (if you have the git manpages installed). The gittutorial and its follow-on documentation are also available online here:

- git tutorial: <https://www.kernel.org/pub/software/scm/git/docs/gittutorial.html>
- git tutorial 2: <https://www.kernel.org/pub/software/scm/git/docs/gittutorial-2.html>
- Everyday git with 20 commands or so: <https://www.kernel.org/pub/software/scm/git/docs/giteveryday.htm>
- Git User's Manual: <https://www.kernel.org/pub/software/scm/git/docs/user-manual.html>

For a more thorough documentation of git see the "Pro Git" book: <https://git-scm.com/book>

Another online tutorial that has been recommended is "Git for the Lazy": [https://wiki.spheredev.org/-index.php/Git\\_for\\_the\\_lazy](https://wiki.spheredev.org/-index.php/Git_for_the_lazy)

## 8.5 Overview of the process

The high-level overview of how to contribute changes to the source goes like this:

- Communicate with the project developers and let us know what you're hacking on. Explain what you are doing, and why.
  - Clone the git repo.
  - Make your changes in a local branch.
-

- Adding documentation and [writing tests](#) is an important part of adding a new feature. Otherwise, others won't know how to use your feature, and if other changes break your feature it can go unnoticed without a test.
- Share your changes with the other project developers in one of these ways:
  - Push your branch to github and create a github pull request to <https://github.com/linuxcnc/linuxcnc> (this requires a github account), or
  - Push your branch to a publicly visible git repo (such as github, or your own publicly-accessible server, etc) and share that location on the emc-developers mailing list, or
  - Email your commits to the LinuxCNC-developers mailing list (<[emc-developers@lists.sourceforge.net](mailto:emc-developers@lists.sourceforge.net)>) (use `git format-patch` to create the patches).
- Advocate for your patch:
  - Explain what problem it addresses and why it should be included in LinuxCNC.
  - Be receptive to questions and feedback from the developer community.
  - It is not uncommon for a patch to go through several revisions before it is accepted.

## 8.6 git configuration

In order to be considered for inclusion in the LinuxCNC source, commits must have correct Author fields identifying the author of the commit. A good way to ensure this is to set your global git config:

```
git config --global user.name "Your full name"
git config --global user.email "you@example.com"
```

Use your real name (not a handle), and use an unobfuscated e-mail address.

## 8.7 Effective use of git

### 8.7.1 Commit contents

Keep your commits small and to the point. Each commit should accomplish one logical change to the repo.

### 8.7.2 Write good commit messages

Keep commit messages around 72 columns wide (so that in a default-size terminal window, they don't wrap when shown by `git log`).

Use the first line as a summary of the intent of the change (almost like the subject line of an e-mail). Follow it with a blank line, then a longer message explaining the change. Example:

### 8.7.3 Commit to the proper branch

Bugfixes should go on the oldest applicable branch. New features should go in the master branch. If you're not sure where a change belongs, ask on irc or on the mailing list.

---

### 8.7.4 Use multiple commits to organize changes

When appropriate, organize your changes into a branch (a series of commits) where each commit is a logical step towards your ultimate goal. For example, first factor out some complex code into a new function. Then, in a second commit, fix an underlying bug. Then, in the third commit, add a new feature which is made easier by the refactoring and which would not have worked without fixing that bug.

This is helpful to reviewers, because it is easier to see that the "factor out code into new function" step was right when there aren't other edits mixed in; it's easier to see that the bug is fixed when the change that fixes it is separate from the new feature; and so on.

### 8.7.5 Follow the style of the surrounding code

Make an effort to follow the prevailing indentation style of surrounding code. In particular, changes to whitespace make it harder for other developers to track changes over time. When reformatting code must be done, do it as a commit separate from any semantic changes.

### 8.7.6 Get rid of `RTAPI_SUCCESS`, use `0` instead

The test "`retval < 0`" should feel familiar; it's the same kind of test you use in userspace (returns `-1` for error) and in kernel space (returns `-ERRNO` for error).

### 8.7.7 Simplify complicated history before sharing with fellow developers

With git, it's possible to record every edit and false start as a separate commit. This is very convenient as a way to create checkpoints during development, but often you don't want to share these false starts with others.

Git provides two main ways to clean history, both of which can be done freely before you share the change:

`git commit --amend` lets you make additional changes to the last thing you committed, optionally modifying the commit message as well. Use this if you realized right away that you left something out of the commit, or if you typo'd the commit message.

`git rebase --interactive upstream-branch` lets you go back through each commit made since you forked your feature branch from the upstream branch, possibly editing commits, dropping commits, or squashing (combining) commits with others. Rebase can also be used to split individual commits into multiple new commits.

### 8.7.8 Make sure every commit builds

If your change consists of several patches, `git rebase -i` may be used to reorder these patches into a sequence of commits which more clearly lays out the steps of your work. A potential consequence of reordering patches is that one might get dependencies wrong - for instance, introducing a use of a variable, and the declaration of that variable only follows in a later patch.

While the branch HEAD will build, not every commit might build in such a case. That breaks `git bisect` - something somebody else might use later on to find the commit which introduced a bug. So beyond making sure your branch builds, it is important to assure every single commit builds as well.

There's an automatic way to check a branch for each commit being buildable - see <https://dustin.sallings.org/2010/03/28/git-test-sequence.html> and the code at <https://github.com/dustin/bindir/blob/master/git-test-sequence>. Use as follows (in this case testing every commit from origin/master to HEAD, including running regression tests):

```
cd linuxcnc-dev
git-test-sequence origin/master.. '(cd src && make && ../scripts/runtests)'
```

This will either report *All is well* or *Broke on <commit>*

## 8.7.9 Renaming files

Please use the ability to rename files very cautiously. Like running `indent` on single files, renames still make it more difficult to follow changes over time. At a minimum, you should seek consensus on irc or the mailing list that the rename is an improvement.

### 8.7.10 Prefer "rebase"

Use `git pull --rebase` instead of bare `git pull` in order to keep a nice linear history. When you rebase, you always retain your work as revisions that are ahead of `origin/master`, so you can do things like `git format-patch` them to share with others without pushing to the central repository.

## 8.8 Translations

The LinuxCNC project uses `gettext` to translate the software into many languages. We welcome contributions and help in this area! Improving and extending the translations is easy: you don't need to know any programming, and you don't need to install any special translation programs or other software.

The easiest way to help with translations is using Weblate, an open-source web service. Our translation project is here:

<https://hosted.weblate.org/projects/linuxcnc/>

Documentation on how to use Weblate is here: <https://docs.weblate.org/en/latest/user/basic.html>

## 8.9 Other ways to contribute

There are many ways to contribute to LinuxCNC, that are not addressed by this document. These ways include:

- Answering questions on the forum, mailing lists, and in IRC
- Reporting bugs on the bug tracker, forum, mailing lists, or in IRC
- Helping test experimental features

## Chapter 9

# Glossary

A listing of terms and what they mean. Some terms have a general meaning and several additional meanings for users, installers, and developers.

### **Acme Screw**

A type of lead-screw that uses an Acme thread form. Acme threads have somewhat lower friction and wear than simple triangular threads, but ball-screws are lower yet. Most manual machine tools use acme lead-screws.

### **Axis**

One of the computer controlled movable parts of the machine. For a typical vertical mill, the table is the X axis, the saddle is the Y axis, and the quill or knee is the Z axis. Angular axes like rotary tables are referred to as A, B, and C. Additional linear axes relative to the tool are called U, V, and W respectively.

### **AXIS(GUI)**

One of the Graphical User Interfaces available to users of LinuxCNC. It features the modern use of menus and mouse buttons while automating and hiding some of the more traditional LinuxCNC controls. It is the only open-source interface that displays the entire tool path as soon as a file is opened.

### **GMOCCAPY (GUI)**

A Graphical User Interfaces available to users of LinuxCNC. It features the use and feel of an industrial control and can be used with touch screen, mouse and keyboard. It support embedded tabs and hal driven user messages, it offers a lot of hal beans to be controlled with hardware. GMOCCAPY is highly customizable.

### **Backlash**

The amount of "play" or lost motion that occurs when direction is reversed in a lead screw. or other mechanical motion driving system. It can result from nuts that are loose on leadscrews, slippage in belts, cable slack, "wind-up" in rotary couplings, and other places where the mechanical system is not "tight". Backlash will result in inaccurate motion, or in the case of motion caused by external forces (think cutting tool pulling on the work piece) the result can be broken cutting tools. This can happen because of the sudden increase in chip load on the cutter as the work piece is pulled across the backlash distance by the cutting tool.

### **Backlash Compensation**

Any technique that attempts to reduce the effect of backlash without actually removing it from the mechanical system. This is typically done in software in the controller. This can correct the final resting place of the part in motion but fails to solve problems related to direction changes while in motion (think circular interpolation) and motion that is caused when external forces (think cutting tool pulling on the work piece) are the source of the motion.

**Ball Screw**

A type of lead-screw that uses small hardened steel balls between the nut and screw to reduce friction. Ball-screws have very low friction and backlash, but are usually quite expensive.

**Ball Nut**

A special nut designed for use with a ball-screw. It contains an internal passage to re-circulate the balls from one end of the screw to the other.

**CNC**

Computer Numerical Control. The general term used to refer to computer control of machinery. Instead of a human operator turning cranks to move a cutting tool, CNC uses a computer and motors to move the tool, based on a part program.

**Comp**

A tool used to build, compile and install LinuxCNC HAL components.

**Configuration(n)**

A directory containing a set of configuration files. Custom configurations are normally saved in the users home/linuxcnc/configs directory. These files include LinuxCNC's traditional INI file and HAL files. A configuration may also contain several general files that describe tools, parameters, and NML connections.

**Configuration(v)**

The task of setting up LinuxCNC so that it matches the hardware on a machine tool.

**Coordinate Measuring Machine**

A Coordinate Measuring Machine is used to make many accurate measurements on parts. These machines can be used to create CAD data for parts where no drawings can be found, when a hand-made prototype needs to be digitized for moldmaking, or to check the accuracy of machined or molded parts.

**Display units**

The linear and angular units used for onscreen display.

**DRO**

A Digital Read Out is a system of position-measuring devices attached to the slides of a machine tool, which are connected to a numeric display showing the current location of the tool with respect to some reference position. DROs are very popular on hand-operated machine tools because they measure the true tool position without backlash, even if the machine has very loose Acme screws. Some DROs use linear quadrature encoders to pick up position information from the machine, and some use methods similar to a resolver which keeps rolling over.

**EDM**

EDM is a method of removing metal in hard or difficult to machine or tough metals, or where rotating tools would not be able to produce the desired shape in a cost-effective manner. An excellent example is rectangular punch dies, where sharp internal corners are desired. Milling operations can not give sharp internal corners with finite diameter tools. A *wire* EDM machine can make internal corners with a radius only slightly larger than the wire's radius. A *sinker* EDM can make internal corners with a radius only slightly larger than the radius on the corner of the sinking electrode.

**EMC**

The Enhanced Machine Controller. Initially a NIST project. Renamed to LinuxCNC in 2012.

**EMCIO**

The module within LinuxCNC that handles general purpose I/O, unrelated to the actual motion of the axes.

**EMCMOT**

The module within LinuxCNC that handles the actual motion of the cutting tool. It runs as a real-time program and directly controls the motors.

---

**Encoder**

A device to measure position. Usually a mechanical-optical device, which outputs a quadrature signal. The signal can be counted by special hardware, or directly by the parport with LinuxCNC.

**Feed**

Relatively slow, controlled motion of the tool used when making a cut.

**Feed rate**

The speed at which a cutting motion occurs. In auto or MDI mode, feed rate is commanded using an F word. F10 would mean ten machine units per minute.

**Feedback**

A method (e.g., quadrature encoder signals) by which LinuxCNC receives information about the position of motors.

**Feedrate Override**

A manual, operator controlled change in the rate at which the tool moves while cutting. Often used to allow the operator to adjust for tools that are a little dull, or anything else that requires the feed rate to be "tweaked".

**Floating Point Number**

A number that has a decimal point. (12.300) In HAL it is known as float.

**G-code**

The generic term used to refer to the most common part programming language. There are several dialects of G-code, LinuxCNC uses RS274/NGC.

**GUI**

Graphical User Interface.

**General**

A type of interface that allows communications between a computer and a human (in most cases) via the manipulation of icons and other elements (widgets) on a computer screen.

**LinuxCNC**

An application that presents a graphical screen to the machine operator allowing manipulation of the machine and the corresponding controlling program.

**HAL**

Hardware Abstraction Layer. At the highest level, it is simply a way to allow a number of building blocks to be loaded and interconnected to assemble a complex system. Many of the building blocks are drivers for hardware devices. However, HAL can do more than just configure hardware drivers.

**Home**

A specific location in the machine's work envelope that is used to make sure the computer and the actual machine both agree on the tool position.

**INI file**

A text file that contains most of the information that configures LinuxCNC for a particular machine.

**Instance**

One can have an instance of a class or a particular object. The instance is the actual object created at runtime. In programmer jargon, the "Lassie" object is an instance of the "Dog" class.

**Joint Coordinates**

These specify the angles between the individual joints of the machine. See also Kinematics

**Jog**

Manually moving an axis of a machine. Jogging either moves the axis a fixed amount for each key-press, or moves the axis at a constant speed as long as you hold down the key. In manual mode, jog speed can be set from the graphical interface.

---

**kernel-space**

Code running inside the kernel, as opposed to code running in userspace. Some realtime systems (like RTAI) run realtime code in the kernel and non-realtime code in userspace, while other realtime systems (like Preempt-RT) run both realtime and non-realtime code in userspace.

**Kinematics**

The position relationship between world coordinates and joint coordinates of a machine. There are two types of kinematics. Forward kinematics is used to calculate world coordinates from joint coordinates. Inverse kinematics is used for exactly the opposite purpose. Note that kinematics does not take into account, the forces, moments etc. on the machine. It is for positioning only.

**Lead-screw**

An screw that is rotated by a motor to move a table or other part of a machine. Lead-screws are usually either ball-screws or acme screws, although conventional triangular threaded screws may be used where accuracy and long life are not as important as low cost.

**Machine units**

The linear and angular units used for machine configuration. These units are specified and used in the INI file. HAL pins and parameters are also generally in machine units.

**MDI**

Manual Data Input. This is a mode of operation where the controller executes single lines of G-code as they are typed by the operator.

**NIST**

National Institute of Standards and Technology. An agency of the Department of Commerce in the United States.

**NML**

Neutral Message Language provides a mechanism for handling multiple types of messages in the same buffer as well as simplifying the interface for encoding and decoding buffers in neutral format and the configuration mechanism.

**Offsets**

An arbitrary amount, added to the value of something to make it equal to some desired value. For example, G-code programs are often written around some convenient point, such as X0, Y0. Fixture offsets can be used to shift the actual execution point of that G-code program to properly fit the true location of the vice and jaws. Tool offsets can be used to shift the "uncorrected" length of a tool to equal that tool's actual length.

**Part Program**

A description of a part, in a language that the controller can understand. For LinuxCNC, that language is RS-274/NGC, commonly known as G-code.

**Program Units**

The linear and angular units used in a part program. The linear program units do not have to be the same as the linear machine units. See G20 and G21 for more information. The angular program units are always measured in degrees.

**Python**

General-purpose, very high-level programming language. Used in LinuxCNC for the Axis GUI, the StepConf configuration tool, and several G-code programming scripts.

**Rapid**

Fast, possibly less precise motion of the tool, commonly used to move between cuts. If the tool meets the workpiece or the fixturing during a rapid, it is probably a bad thing!

**Rapid rate**

The speed at which a rapid motion occurs. In auto or MDI mode, rapid rate is usually the maximum speed of the machine. It is often desirable to limit the rapid rate when testing a G-code program for the first time.

---



**Real-time**

Software that is intended to meet very strict timing deadlines. On Linux, in order to meet these requirements it is necessary to install a realtime kernel such as RTAI or Preempt-RT, and build the LinuxCNC software to run in the special real-time environment. Realtime software can run in the kernel or in userspace, depending on the facilities offered by the system.

**RTAI**

Real Time Application Interface, see <https://www.rtai.org/>, the real-time extensions for Linux that LinuxCNC can use to achieve real-time performance.

**RTLINUX**

See <https://en.wikipedia.org/wiki/RTLinux>, an older real-time extension for Linux that LinuxCNC used to use to achieve real-time performance. Obsolete, replaced by RTAI.

**RTAPI**

A portable interface to real-time operating systems including RTAI and POSIX pthreads with realtime extensions.

**RS-274/NGC**

The formal name for the language used by LinuxCNC part programs.

**Servo Motor**

Generally, any motor that is used with error-sensing feedback to correct the position of an actuator. Also, a motor which is specially-designed to provide improved performance in such applications.

**Servo Loop**

A control loop used to control position or velocity of a motor equipped with a feedback device.

**Signed Integer**

A whole number that can have a positive or negative sign. In HAL it is usually a `s32`, but could be also a `s64`.

**Spindle**

The part of a machine tool that spins to do the cutting. On a mill or drill, the spindle holds the cutting tool. On a lathe, the spindle holds the workpiece.

**Spindle Speed Override**

A manual, operator controlled change in the rate at which the tool rotates while cutting. Often used to allow the operator to adjust for chatter caused by the cutter's teeth. Spindle Speed Override assumes that the LinuxCNC software has been configured to control spindle speed.

**StepConf**

An LinuxCNC configuration wizard. It is able to handle many step-and-direction motion command based machines. It writes a full configuration after the user answers a few questions about the computer and machine that LinuxCNC is to run on.

**Stepper Motor**

A type of motor that turns in fixed steps. By counting steps, it is possible to determine how far the motor has turned. If the load exceeds the torque capability of the motor, it will skip one or more steps, causing position errors.

**TASK**

The module within LinuxCNC that coordinates the overall execution and interprets the part program.

**Tcl/Tk**

A scripting language and graphical widget toolkit with which several of LinuxCNCs GUIs and selection wizards were written.

**Traverse Move**

A move in a straight line from the start point to the end point.

---

**Units**

See "Machine Units", "Display Units", or "Program Units".

**Unsigned Integer**

A whole number that has no sign. In HAL it is usually a [u32](#) but could be also a [u64](#).

**World Coordinates**

This is the absolute frame of reference. It gives coordinates in terms of a fixed reference frame that is attached to some point (generally the base) of the machine tool.

# Chapter 10

## Legal Section

Translations of this file provided in the source tree are not legally binding.

### 10.1 Copyright Terms

**Copyright (c) 2000-2022 LinuxCNC.org**

Permission is granted to copy, distribute and/or modify this document under the terms of the GNU Free Documentation License, Version 1.1 or any later version published by the Free Software Foundation; with no Invariant Sections, no Front-Cover Texts, and no Back-Cover Texts. A copy of the license is included in the section entitled "GNU Free Documentation License".

### 10.2 GNU Free Documentation License

**GNU Free Documentation License Version 1.1, March 2000**

Copyright © 2000 Free Software Foundation, Inc. 51 Franklin Street, Fifth Floor, Boston, MA 02110-1301 USA. Everyone is permitted to copy and distribute verbatim copies of this license document, but changing it is not allowed.

#### **0. PREAMBLE**

The purpose of this License is to make a manual, textbook, or other written document "free" in the sense of freedom: to assure everyone the effective freedom to copy and redistribute it, with or without modifying it, either commercially or noncommercially. Secondly, this License preserves for the author and publisher a way to get credit for their work, while not being considered responsible for modifications made by others.

This License is a kind of "copyleft", which means that derivative works of the document must themselves be free in the same sense. It complements the GNU General Public License, which is a copyleft license designed for free software.

We have designed this License in order to use it for manuals for free software, because free software needs free documentation: a free program should come with manuals providing the same freedoms that the software does. But this License is not limited to software manuals; it can be used for any textual work, regardless of subject matter or whether it is published as a printed book. We recommend this License principally for works whose purpose is instruction or reference.

#### **1. APPLICABILITY AND DEFINITIONS**

---

This License applies to any manual or other work that contains a notice placed by the copyright holder saying it can be distributed under the terms of this License. The “Document”, below, refers to any such manual or work. Any member of the public is a licensee, and is addressed as “you”.

A “Modified Version” of the Document means any work containing the Document or a portion of it, either copied verbatim, or with modifications and/or translated into another language.

A “Secondary Section” is a named appendix or a front-matter section of the Document that deals exclusively with the relationship of the publishers or authors of the Document to the Document’s overall subject (or to related matters) and contains nothing that could fall directly within that overall subject. (For example, if the Document is in part a textbook of mathematics, a Secondary Section may not explain any mathematics.) The relationship could be a matter of historical connection with the subject or with related matters, or of legal, commercial, philosophical, ethical or political position regarding them.

The “Invariant Sections” are certain Secondary Sections whose titles are designated, as being those of Invariant Sections, in the notice that says that the Document is released under this License.

The “Cover Texts” are certain short passages of text that are listed, as Front-Cover Texts or Back-Cover Texts, in the notice that says that the Document is released under this License.

A “Transparent” copy of the Document means a machine-readable copy, represented in a format whose specification is available to the general public, whose contents can be viewed and edited directly and straightforwardly with generic text editors or (for images composed of pixels) generic paint programs or (for drawings) some widely available drawing editor, and that is suitable for input to text formatters or for automatic translation to a variety of formats suitable for input to text formatters. A copy made in an otherwise Transparent file format whose markup has been designed to thwart or discourage subsequent modification by readers is not Transparent. A copy that is not “Transparent” is called “Opaque”.

Examples of suitable formats for Transparent copies include plain ASCII without markup, Texinfo input format, LaTeX input format, SGML or XML using a publicly available DTD, and standard-conforming simple HTML designed for human modification. Opaque formats include PostScript, PDF, proprietary formats that can be read and edited only by proprietary word processors, SGML or XML for which the DTD and/or processing tools are not generally available, and the machine-generated HTML produced by some word processors for output purposes only.

The “Title Page” means, for a printed book, the title page itself, plus such following pages as are needed to hold, legibly, the material this License requires to appear in the title page. For works in formats which do not have any title page as such, “Title Page” means the text near the most prominent appearance of the work’s title, preceding the beginning of the body of the text.

## **2. VERBATIM COPYING**

You may copy and distribute the Document in any medium, either commercially or noncommercially, provided that this License, the copyright notices, and the license notice saying this License applies to the Document are reproduced in all copies, and that you add no other conditions whatsoever to those of this License. You may not use technical measures to obstruct or control the reading or further copying of the copies you make or distribute. However, you may accept compensation in exchange for copies. If you distribute a large enough number of copies you must also follow the conditions in section 3.

You may also lend copies, under the same conditions stated above, and you may publicly display copies.

## **3. COPYING IN QUANTITY**

If you publish printed copies of the Document numbering more than 100, and the Document’s license notice requires Cover Texts, you must enclose the copies in covers that carry, clearly and legibly, all these Cover Texts: Front-Cover Texts on the front cover, and Back-Cover Texts on the back cover. Both covers must also clearly and legibly identify you as the publisher of these copies. The front cover must present the full title with all words of the title equally prominent and visible. You may add other material on the covers in addition. Copying with changes limited to the covers, as long as they preserve the title of the Document and satisfy these conditions, can be treated as verbatim copying in other respects.

---

If the required texts for either cover are too voluminous to fit legibly, you should put the first ones listed (as many as fit reasonably) on the actual cover, and continue the rest onto adjacent pages.

If you publish or distribute Opaque copies of the Document numbering more than 100, you must either include a machine-readable Transparent copy along with each Opaque copy, or state in or with each Opaque copy a publicly-accessible computer-network location containing a complete Transparent copy of the Document, free of added material, which the general network-using public has access to download anonymously at no charge using public-standard network protocols. If you use the latter option, you must take reasonably prudent steps, when you begin distribution of Opaque copies in quantity, to ensure that this Transparent copy will remain thus accessible at the stated location until at least one year after the last time you distribute an Opaque copy (directly or through your agents or retailers) of that edition to the public.

It is requested, but not required, that you contact the authors of the Document well before redistributing any large number of copies, to give them a chance to provide you with an updated version of the Document.

#### 4. MODIFICATIONS

You may copy and distribute a Modified Version of the Document under the conditions of sections 2 and 3 above, provided that you release the Modified Version under precisely this License, with the Modified Version filling the role of the Document, thus licensing distribution and modification of the Modified Version to whoever possesses a copy of it. In addition, you must do these things in the Modified Version:

- A. Use in the Title Page (and on the covers, if any) a title distinct from that of the Document, and from those of previous versions (which should, if there were any, be listed in the History section of the Document). You may use the same title as a previous version if the original publisher of that version gives permission.
- B. List on the Title Page, as authors, one or more persons or entities responsible for authorship of the modifications in the Modified Version, together with at least five of the principal authors of the Document (all of its principal authors, if it has less than five).
- C. State on the Title page the name of the publisher of the Modified Version, as the publisher.
- D. Preserve all the copyright notices of the Document.
- E. Add an appropriate copyright notice for your modifications adjacent to the other copyright notices.
- F. Include, immediately after the copyright notices, a license notice giving the public permission to use the Modified Version under the terms of this License, in the form shown in the Addendum below.
- G. Preserve in that license notice the full lists of Invariant Sections and required Cover Texts given in the Document's license notice.
- H. Include an unaltered copy of this License.
- I. Preserve the section entitled "History", and its title, and add to it an item stating at least the title, year, new authors, and publisher of the Modified Version as given on the Title Page. If there is no section entitled "History" in the Document, create one stating the title, year, authors, and publisher of the Document as given on its Title Page, then add an item describing the Modified Version as stated in the previous sentence.
- J. Preserve the network location, if any, given in the Document for public access to a Transparent copy of the Document, and likewise the network locations given in the Document for previous versions it was based on. These may be placed in the "History" section. You may omit a network location for a work that was published at least four years before the Document itself, or if the original publisher of the version it refers to gives permission.
- K. In any section entitled "Acknowledgements" or "Dedications", preserve the section's title, and preserve in the section all the substance and tone of each of the contributor acknowledgements and/or dedications given therein.
- L. Preserve all the Invariant Sections of the Document, unaltered in their text and in their titles. Section numbers or the equivalent are not considered part of the section titles.
- M. Delete any section entitled "Endorsements". Such a section may not be included in the Modified Version.
- N. Do not retitle any existing section as "Endorsements" or to conflict in title with any Invariant Section.

If the Modified Version includes new front-matter sections or appendices that qualify as Secondary Sections and contain no material copied from the Document, you may at your option designate some or all of these sections as invariant. To do this, add their titles to the list of Invariant Sections in the Modified Version's license notice. These titles must be distinct from any other section titles.

---

You may add a section entitled "Endorsements", provided it contains nothing but endorsements of your Modified Version by various parties—for example, statements of peer review or that the text has been approved by an organization as the authoritative definition of a standard.

You may add a passage of up to five words as a Front-Cover Text, and a passage of up to 25 words as a Back-Cover Text, to the end of the list of Cover Texts in the Modified Version. Only one passage of Front-Cover Text and one of Back-Cover Text may be added by (or through arrangements made by) any one entity. If the Document already includes a cover text for the same cover, previously added by you or by arrangement made by the same entity you are acting on behalf of, you may not add another; but you may replace the old one, on explicit permission from the previous publisher that added the old one.

The author(s) and publisher(s) of the Document do not by this License give permission to use their names for publicity for or to assert or imply endorsement of any Modified Version.

## **5. COMBINING DOCUMENTS**

You may combine the Document with other documents released under this License, under the terms defined in section 4 above for modified versions, provided that you include in the combination all of the Invariant Sections of all of the original documents, unmodified, and list them all as Invariant Sections of your combined work in its license notice.

The combined work need only contain one copy of this License, and multiple identical Invariant Sections may be replaced with a single copy. If there are multiple Invariant Sections with the same name but different contents, make the title of each such section unique by adding at the end of it, in parentheses, the name of the original author or publisher of that section if known, or else a unique number. Make the same adjustment to the section titles in the list of Invariant Sections in the license notice of the combined work.

In the combination, you must combine any sections entitled "History" in the various original documents, forming one section entitled "History"; likewise combine any sections entitled "Acknowledgements", and any sections entitled "Dedications". You must delete all sections entitled "Endorsements."

## **6. COLLECTIONS OF DOCUMENTS**

You may make a collection consisting of the Document and other documents released under this License, and replace the individual copies of this License in the various documents with a single copy that is included in the collection, provided that you follow the rules of this License for verbatim copying of each of the documents in all other respects.

You may extract a single document from such a collection, and distribute it individually under this License, provided you insert a copy of this License into the extracted document, and follow this License in all other respects regarding verbatim copying of that document.

## **7. AGGREGATION WITH INDEPENDENT WORKS**

A compilation of the Document or its derivatives with other separate and independent documents or works, in or on a volume of a storage or distribution medium, does not as a whole count as a Modified Version of the Document, provided no compilation copyright is claimed for the compilation. Such a compilation is called an "aggregate", and this License does not apply to the other self-contained works thus compiled with the Document, on account of their being thus compiled, if they are not themselves derivative works of the Document.

If the Cover Text requirement of section 3 is applicable to these copies of the Document, then if the Document is less than one quarter of the entire aggregate, the Document's Cover Texts may be placed on covers that surround only the Document within the aggregate. Otherwise they must appear on covers around the whole aggregate.

## **8. TRANSLATION**

Translation is considered a kind of modification, so you may distribute translations of the Document under the terms of section 4. Replacing Invariant Sections with translations requires special permission from their copyright holders, but you may include translations of some or all Invariant Sections in addition to the original versions of these Invariant Sections. You may include a translation of

---

this License provided that you also include the original English version of this License. In case of a disagreement between the translation and the original English version of this License, the original English version will prevail.

## 9. TERMINATION

You may not copy, modify, sublicense, or distribute the Document except as expressly provided for under this License. Any other attempt to copy, modify, sublicense or distribute the Document is void, and will automatically terminate your rights under this License. However, parties who have received copies, or rights, from you under this License will not have their licenses terminated so long as such parties remain in full compliance.

## 10. FUTURE REVISIONS OF THIS LICENSE

The Free Software Foundation may publish new, revised versions of the GNU Free Documentation License from time to time. Such new versions will be similar in spirit to the present version, but may differ in detail to address new problems or concerns. See <https://www.gnu.org/copyleft/>.

Each version of the License is given a distinguishing version number. If the Document specifies that a particular numbered version of this License "or any later version" applies to it, you have the option of following the terms and conditions either of that specified version or of any later version that has been published (not as a draft) by the Free Software Foundation. If the Document does not specify a version number of this License, you may choose any version ever published (not as a draft) by the Free Software Foundation.

### **ADDENDUM:** How to use this License for your documents

To use this License in a document you have written, include a copy of the License in the document and put the following copyright and license notices just after the title page:

Copyright (c) YEAR YOUR NAME. Permission is granted to copy, distribute and/or modify this document under the terms of the GNU Free Documentation License, Version 1.1 or any later version published by the Free Software Foundation; with the Invariant Sections being LIST THEIR TITLES, with the Front-Cover Texts being LIST, and with the Back-Cover Texts being LIST. A copy of the license is included in the section entitled "GNU Free Documentation License".

If you have no Invariant Sections, write "with no Invariant Sections" instead of saying which ones are invariant. If you have no Front-Cover Texts, write "no Front-Cover Texts" instead of "Front-Cover Texts being LIST"; likewise for Back-Cover Texts.

If your document contains nontrivial examples of program code, we recommend releasing these examples in parallel under your choice of free software license, such as the GNU General Public License, to permit their use in free software.

---